



Genel
Katalog





Sürdürülebilir ve aydınlık bir gelecek için
yeni nesil teknolojiler...



VİKO, İstanbul Sancaktepe'de 50.000 m² kapalı alana sahip, Türkiye'nin sektöründeki en büyüğü olarak tanımlanan endüstriyel tesislerinde elektrik enerjisinin aktarılması, kullanılması ve daha kolay sunumu amacıyla çözümler üretmektedir.

VİKO'nun ürün gamı içerisinde elektrik anahtar ve prizleri, grup prizler, sigorta kutuları, aksesuarlar, koruma ve kumanda amaçlı otomatik sigortalardan açık tip kesicilere, kontaktörlerden motor koruma şalterlerine, enerji yönetimi ve ölçme alanında ise monofaze, trifaze ve kombi elektronik sayaçları yer almaktadır.

VİKO, Türkiye pazarlarında liderliğini korurken, satışlarının yüzde 50'si 66 ülkeye yaptığı ihracattan oluşmaktadır. Dünya pazarlarında da başarıyla ülkemizi temsil etmekte ve pek çok yeni ürün piyasaya sunmak için, AR-GE, tasarım ve markalaşma yatırımlarını hızla sürdürmektedir.

Thea marka anahtar serilerinde dünyada ilk kez Led teknolojisi ile anahtarı buluşturan VİKO, dünyada bir ilki gerçekleştirerek birçok farklı kuruluş tarafından ödülle layık görülmüştür. "Türkiye'nin İlk 500 Büyük Sanayi Kuruluşu" içerisinde 329'uncu sırada yer alan VİKO, ISO 9001 Kalite Yönetim Sistemi, ISO 14001 Çevre Yönetim Sistemi, OHSAS 18001 İş Sağlığı ve Güvenliği Yönetim Sistemi belgeleri ve TUSİAD-KALDER Ulusal Kalite Başarı Ödülü sahibidir. Sektöründe Turquality marka destek programı kapsamına alınan ilk kuruluştur.







Genel
Katalog

- 6/13** Karre
14/19 Carmen Opak
20/25 Carmen Plus
26/31 Kardelen
32/37 Yasemin
38/43 Vera (Sıva Üstü)
44/49 Palmiye (Nemli Yer Serisi)
50/57 Sigorta Kutuları
58/65 Grup Priz ve Aksesuarlar
66/79 Teknik Özellikler



Ürün Grupları

Karre



Beyaz



Krem

Carmen Opak



Beyaz



Krem

Carmen Plus



Beyaz



Krem

Kardelen



Beyaz



Krem

Yasemin



Beyaz



Krem

Vera



Beyaz

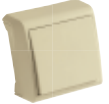

Krem



Maun



Meşe

Palmiye



Gri



Krem



Beyaz

Sigorta Kutuları



Mühürlü



Sivaaltı



Sivaüstü

Grup Priz ve Aksesuarlar



Leylak

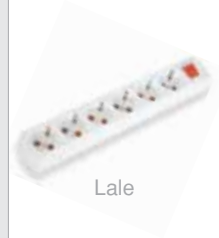

Lale



Yonca



Karre

Minimal şıklık





Karre



Ana Renkler



Beyaz



Krem

Yaşam alanlarının güzelliğini tek bir dokunuşla tamamlayan VİKO, bulunduğu mekanlarda sektör liderliğini yansıtıyor. Sürdürülebilir aydınlık bir gelecek hedefinin ışığında, keskin hatlara ve soylu renklere sahip, minimalist Karre serisiyle, şıklığı hayatın bir parçası yapıyor.

Karre, Easy Connect özelliği sayesinde elektrik kablosuna kolayca bağlanıyor. Yuvasına hemen oturuyor. Beyaz ve Krem renk seçenekleriyle Karre anahtar ve priz serisi, ikili, üçlü, dördü, beşli, altılı yatay ve dikey çerçeveleriyle farklı kullanım alanları için alternatif çözümler sunuyor.

Sıva Üstü Kasalar



Sıva Üstü Beyaz



Sıva Üstü Krem



Sıva Üstü Beyaz Kasa
90969001



Sıva Üstü Krem Kasa
90969011

Sıva üstü kullanımlar için, sıva üstü kasalar en ideal çözümü sunmaktadır. Karre ürün grubuna ait bütün ürünler sıva üstü kasaları ile birlikte kullanılabilir.

Yatay Çerçeveler



Ikili Yatay Çerçeve
909602X1
90966401
(154 x 81 mm)



Üçlü Yatay Çerçeve
909602X2
90966402
(225 x 81 mm)



Dörtlü Yatay Çerçeve
909602X3
90966403
(296 x 81 mm)



Beşli Yatay Çerçeve
909602X4
90966404
(367 x 81 mm)



Altılı Yatay Çerçeve
909602X5
90966405
(438 x 81 mm)

Dikey Çerçeveler



Ikili Dikey Çerçeve
909602X1
90966411
(81 x 154 mm)



Üçlü Dikey Çerçeve
909602X2
90966412
(81 x 225 mm)



Dörtlü Dikey Çerçeve
909602X3
90966413
(81 x 296 mm)



Beşli Dikey Çerçeve
909602X4
90966414
(81 x 367 mm)



Altılı Dikey Çerçeve
909602X5
90966415
(81 x 438 mm)

Karre beyaz ve krem çerçeve seçenekleri;
ikili, üçlü, dörtlü, beşli ve altılı yatay ve dikey
uygulama çözümleri sunmaktadır.

Ürün Ölçüleri

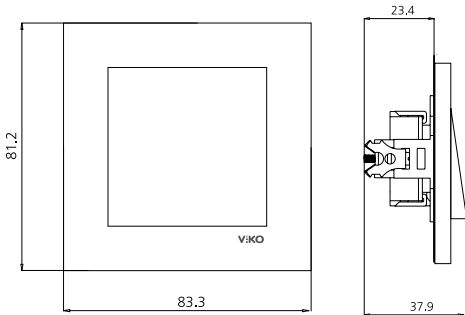



Anahar
90960X01
90966001



Işıklı Anahar
90960X19
90966019



Light
90960X03
90966003



Işıklı Light
90960X14
90966014



Kapı Otomatığı
90960X05
90966005



Zil Anaharı
90960X06
90966006



Işıklı Etiketli Zil
90960X27
90966027



Permütatör (Ara Veavien)
90960X31
90966031



Veavien
90960X04
90966004



Işıklı Veavien
90960X63
90966063



Komütatör Veavien
90960X17
90966017



Komütatör
90960X02
90966002

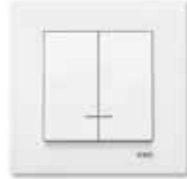

Işıklı Komütatör
90960X50
90966050



Üçlü Anahar
90960X68
90966068



Tek Düğmeli Jaluzi Anaharı
90960X72
90966072



Jaluzi Kumanda Anaharı
90960X16
90966016



600W RL Dimmer
90960X20
90966020



1000W RL Dimmer
90960X69
90966069



400W RC Dimmer
90960X47
90966047



Veavien Dimmer
90960X40
90966040



Müzik Yayın Anaharı
90960X54
90966054



Müzik Yayın Anaharı
90960X80
90960X28 (Acil Anonslu Trafo)
90966080
90966028 (Acil Anonslu Trafo)



Kanal Seçme Anaharı
90960X82
90966082



Priz
90960X07
90966007



Çocuk Korumalı Priz
90960X43
90966043



Topraklı Priz
90960X08
90966008



Çocuk Korumalı Topraklı Priz
90960X42
90966042



Çocuk Korumalı Kapaklı Topraklı Priz
90960X12
90966012



Çocuk Korumalı UPS Priz
90960X45
90966045



İkili Priz
90960X55
90966055



Çocuk Korumalı İkili Priz
90960X46
90966046



İkili Topraklı Priz
90960X56
90966056



Çocuk Korumalı İkili Topraklı Priz
90960X58
90966058



Çocuk Korumalı İkili UPS Priz
90960X57
90966057



TV Priz Dirençsiz
90960X49
90966049



TV Radyo Priz Sonlu (TV-RD)
90960X21
90966021



Uydu Priz F Konnektörlü
90960X09 Sonlu
90960X38 Geçişli (10dB)
90966009 Sonlu
90966038 Geçişli (10dB)



TV Uydu Priz Sonlu (TV-SAT)
90960X85
90966085



TV Radyo Uydu Priz Sonlu (SAT-TV-RD)
90960X41
90966041



İkili Uydu Priz Sonlu (SAT-SAT-TV)
90960X53
90966053



Müzik Yayın Priz
90960X37
90966037



Tekli Nümeris Priz - RJ11
90960X13
90966013



İkili Nümeris Priz - 2xRJ11
90960X33
90966033



Data - Nümeris Priz (RJ11-RJ45)
90960X35 (Cat5e)
90960X81 (Cat6)
90966035 (Cat5e)
90966081 (Cat6)



Data Priz Jaksız
90960X73
90966073



Tekli Data Priz - RJ45
90960X32 (Cat5e)
90960X78 (Cat6)
90966032 (Cat5e)
90966078 (Cat6)



İkili Data Priz - 2XRJ45
90960X34
90966034



Kablo Çıkış Kapağı
90960X77
90966077



Energy Saver Standart
90960X51
90966051



Energy Saver Barkodlu
90960X65
90966065



Energy Saver RF
90960X**
909660**



karre

antibacterial



Daha sağlıklı, temiz ve
mikroplardan uzak bir yaşam için
VIKO'dan KARRE ANTİBAKTERİYEL.



KARRE ANTİBAKTERİYEL, ÇÜNKÜ TEMİZLİK ÖNEMLİDİR.

- Gümüş iyonlarıyla antibakteriyel özellik
- Işığa ve sıcaklığa karşı dayanıklı
- Kendi kendini temizleyebilme
- Sağlıklı
- Hijyenik

Özellikle bağışıklık sistemi onları koruyacak kadar güçlü olmayan çocuklar ve daha hijyenik bir ortam arayanlar için VIKO'dan antibakteriyel özellikli anahtar serisi: KARRE ANTİBAKTERİYEL İnorganik nano gümüş iyonlarıyla etkin antibakteriyel özelliğe sahip KARRE, mikropları hayatımızın dışına çıkarıyor. Evlerde, okullarda, hastanelerde, alışveriş merkezlerinde ve ortak kullanılan tüm mekanlarda daha sağlıklı ve daha hijyenik bir hayat için KARRE ANTİBAKTERİYEL...

KARRE ANTİBAKTERİYEL... VİKO'DAN ÜZERİNDE BAKTERİ TUTMAYAN BİR SERİ.

VİKO, yeni antibakteriyel özellikli KARRE ile okul, kreş, spor salonları, hastane gibi kalabalık alanlarda ve evlerinde mikroplardan etkilenmeden yaşamak isteyenler için önemli bir adım atıyor. Hemen her gün temas ettiğimiz alanların çoğalan bakterilere, mantarlara, küfe ve kötü kokuyla

MİKROPLARA VE BAKTERİLERE KARŞI EVLERDE, OKULLARDA, KREŞLERDE, HASTANELERDE, SPOR SALONLARINDA KARRE ANTİBAKTERİYEL.

KARRE ANTİBAKTERİYEL yüzeyindeki özel maddesiyle mikropları öldürmek için savaşıyor. Kısaca kendi kendini temizliyor. Günboyu, mikrop üremesine mani oluyor. KARRE ANTİBAKTERİYEL gücünü ve özelliğini gümüş iyonlarından alıyor. Peki, neden gümüş? Çünkü, gümüş oldukça uzun bir kullanım geçmişine sahip. Gümüşe dayalı antibakteriyel yüzeyler rahatlıkla bakterilerin yol açtığı kokulara, küfün neden olduğu lekeler ve renk değişimlerine karşı savaşabiliyorlar. Mikroplar yüzeylerinde eksi yüke sahiptirler ve artı yüke sahip gümüş iyonlarını kendilerine doğru çekerler.



birlikte kire neden olan diğer mikroplara karşı korumalı olduğunu hayal edin. İşte, KARRE ANTİBAKTERİYEL böyle bir fikirden doğdu.

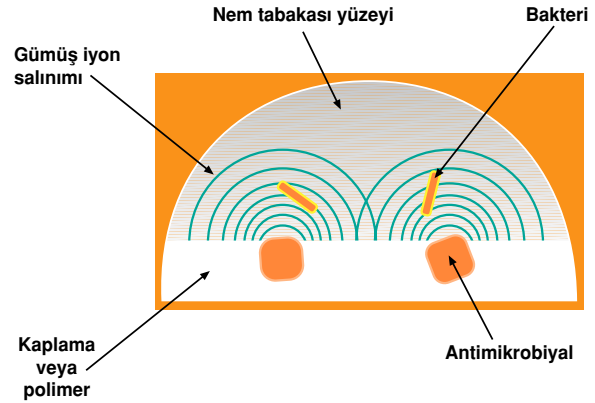

Gümüş iyonlu KARRE, ihtiyaç oldukça ortaya çıkan gümüş salınımı ile hem mikropların iç dengesini bozuyor hem de onları etkisiz hale getiriyor.

Üstelik VİKO KARRE'nin antibakteriyel yapısı ışık ve sıcaklıktan da etkilenmiyor. Mikroplara karşı sizin için mücadele ediyor.



Carmen
Opak

Hayatı şıklaştıran tasarım





Carmen Opak



Ana Renkler



Beyaz



Krem

Carmen Opak, hayatın içinden gelen çizgilerle tasarlandı. Ev kadar sıcak tasarımı, zaman kadar akıcı hatları sayesinde şimdi tüm dikkatler onun üzerinde. Dekorasyon tercihleriyle uyumlu bir bütünlük yakalayan Carmen Opak, beyaz, krem renk seçenekleri ve 90'ın üzerinde mekanizma opsiyonuyla sunuluyor. Carmen Opak diğer yandan ikili, üçlü, beşli, altılı olarak yatay ve dikey çerçeve uygulamasıyla da göz dolduruyor.

VİKO kalitesini yaşam alanlarına taşıyan Carmen Opak'ın pratik olarak tek seferde duvara monte olan daimi mekanizması ise ayrıcalıklardan sadece bir tanesi. Farklı kapak ve çerçeve renkleriyle kombinlenebilen bu özel mekanizma ile mekanlar için tek düzelik tarihe karışıyor.

Sıva Üstü Kasalar



Sıva Üstü Beyaz



Sıva Üstü Krem



Sıva Üstü Beyaz Kasa
90571009



Sıva Üstü Krem Kasa
90572009

Sıva üstü kullanımlar için, sıva üstü kasalar en ideal çözümleri sunmaktadır. Carmen Opak ürün grubuna ait bütün ürünler sıva üstü kasaları ile birlikte kullanılabilir.

Yatay Çerçevesler



İkili Yatay Çerçeve
9057Y102
(153.5 x 80.5 mm)



Üçlü Yatay Çerçeve
9057Y103
(224.5 x 80.5 mm)



Dörtlü Yatay Çerçeve
9057Y104
(295.5 x 80.5 mm)



Beşli Yatay Çerçeve
9057Y105
(366.5 x 80.5 mm)



Altılı Yatay Çerçeve
9057Y106
(437.5 x 80.5 mm)

Dikey Çerçevesler



İkili Dikey Çerçeve
9057Y002
(82.5 x 151.5 mm)



Üçlü Dikey Çerçeve
9057Y003
(82.5 x 222.5 mm)



Dörtlü Dikey Çerçeve
9057Y004
(82.5 x 293.5 mm)



Beşli Dikey Çerçeve
9057Y005
(82.5 x 364.5 mm)



Altılı Dikey Çerçeve
9057Y006
(82.5 x 435.5 mm)

Carmen Opak beyaz ve krem çerçeve seçenekleri; ikili, üçlü, dörtlü, beşli ve altılı yatay ve dikey uygulama çözümleri sunmaktadır.

Ürün Ölçüleri

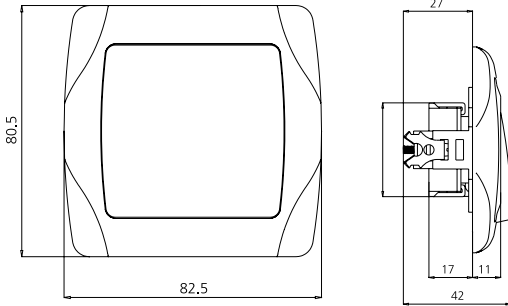



Anahtar
9056X001



İşıkli Anahtar
90960X19



Light
9056X003



İşıkli Light
9056X014



Kapı Otomatığı
9056X005



Zil Anahtarı
9056X006



İşıkli Etiketli Zil
9056X027



Permütatör (Ara Veavien)
9056X031



Veavien
9056X004



İşıkli Veavien
9056X063



Komütatör Veavien
9056X017



Komütatör
9056X002



İşıkli Komütatör
9056X050



Üçlü Anahtar
9056X068



Tek Düğmeli Jaluzi Anahtarı
9056X072



Jaluzi Kumanda Anahtarı
9056X016



600W RL Dimmer
9056X020



1000W RL Dimmer
9056X069



400W RC Dimmer
9056X090



Veavien Dimmer
9056X040



Dokunmatik Dimmer
9056X076



Müzik Yayın Anahtarı
9056X054
9056X080 (Trafolu)
9056X091 (Acil Anonlu Trafolu)



Kanal Seçme Anahtarı
9056X082



Priz
9056X007



Çocuk Korumalı Priz
9056X043



Topraklı Priz
9056X008



Çocuk Korumalı Topraklı Priz
9056X042



Çocuk Korumalı UPS Priz
9056X045



Ikili Priz
9056X055



Ikili Topraklı Priz
9056X056



Çocuk Korumalı İkili UPS Priz
9056X057



Çocuk Korumalı Kapaklı Topraklı Priz
9056X012



TV Priz
9056X010 (Sonlu)
9056X060 (Geçişli)
9056X049 (Direncsiz)



TV Radyo Priz (TV-RD)
9056X021 (Sonlu)
9056X022-25 (Geçişli)



Uydu Priz F Konnektörlü
9056X096 (Sonlu)
9056X097 (Geçişli 10dB)



TV Uydu Priz (TV-SAT)
9056X085 (Sonlu)
9056X086-87 (Geçişli)



TV Radyo Uydu Priz (SAT-TV-RD)
9056X041 (Sonlu)
9056X052 (Geçişli)



İkili Uydu Priz (SAT-SAT-TV-RD)
9056X053



Müzik Yayın Priz
9056X037



Telefon Priz
9056X011



Nümeris Telefon Priz (RJ11)
9056X013



İkili Nümeris Telefon Priz (2 x RJ11)
9056X033



Data-Nümeris Telefon Priz (RJ45-RJ11)
9056X035 (Cat5E)
9056X335 (Cat6)



Data Priz Jaksız
9056X132



Tekli Data Priz (RJ45)
9056X032 (Cat5E)
9056X332 (Cat6)



İkili Data Priz (2 x RJ45)
9056X034 (Cat5E)
9056X334 (Cat6)



Energy Saver-Standart (Röle Hariç)
9056X051
90551152 (Logolu Anahtarlık)



Kablo Çıkış Kapağı
9056X077



Energy Saver Kartlı (Röle Hariç)
9056X065
90551163 (Kart)
9056X0** RF



**Carmen
Plus**



Seçme özgürlüğü





Carmen Plus



Ana Renkler



Beyaz



Krem

VİKO'nun detaylara işleyen profesyonelliği sayesinde Carmen Plus ile yaşam alanları özgürlüğün yeni yüzüyle tanıştı.

Çarpıcı tasarımı, fonksiyonel yapısı ve özgün renk seçenekleri Carmen Plus'ı hemen her mekan için öncelikli tercihler arasında ilk sıralara taşıyor. Beyaz ve krem renk seçenekleri eşliğinde 14 farklı kordon rengiyle özgün kombinasyonlar oluşturma imkanı sunan Carmen Plus'ın uygulandığı mekanlar geleneksel sınırların ötesine geçiyor.

Sıva Üstü Kasalar



Sıva Üstü Beyaz



Sıva Üstü Krem



Sıva Üstü Beyaz Kasa
90571009



Sıva Üstü Krem Kasa
90572009

Sıva üstü kullanımlar için, sıva üstü kasalar en ideal çözümleri sunmaktadır. Carmen Plus ürün grubuna ait bütün ürünler sıva üstü kasaları ile birlikte kullanılabilir.

Yatay Çerçevesler



İkili Yatay Çerçeve
9057X302
(153.5 x 80.5 mm)



Üçlü Yatay Çerçeve
9057X303
(224.5 x 80.5 mm)



Dörtlü Yatay Çerçeve
9057X304
(295.5 x 80.5 mm)



Beşli Yatay Çerçeve
9057X305
(366.5 x 80.5 mm)



Altılı Yatay Çerçeve
9057X306
(437.5 x 80.5 mm)

Dikey Çerçevesler



İkili Dikey Çerçeve
9057X202
(82.5 x 151.5 mm)



Üçlü Dikey Çerçeve
9057X203
(82.5 x 222.5 mm)



Dörtlü Dikey Çerçeve
9057X204
(82.5 x 293.5 mm)



Beşli Dikey Çerçeve
9057X205
(82.5 x 364.5 mm)



Altılı Dikey Çerçeve
9057X206
(82.5 x 435.5 mm)

Carmen Plus beyaz ve krem çerçeve seçenekleri; ikili, üçlü, dörtlü, beşli ve altılı yatay ve dikey uygulama çözümleri sunmaktadır.

Kordon Renkleri



Beyaz-Kum Beji
90611001
Krem-Kum Beji
90611041



Beyaz-Su Yeşilli
90611002
Krem-Su Yeşilli
90611042



Beyaz-Bulut Grisi
90611003
Krem-Bulut Grisi
90611043



Beyaz-Çelik Grisi
90611004
Krem-Çelik Grisi
90611044



Beyaz-Saten Dore
90611005
Krem-Saten Dore
90611045



Beyaz-Lal Kırmızısı
90611006
Krem-Lal Kırmızısı
90611046



Beyaz-Granit Yeşilli
90611007
Krem-Granit Yeşilli
90611047



Beyaz-Tropik Kahve
90611008
Krem-Tropik Kahve
90611048



Beyaz-Fırtına Mavisi
90611009
Krem-Fırtına Mavisi
90611049



Beyaz-Koyu Fuşya
90611010
Krem-Koyu Fuşya
90611050



Bulut Grisi-Çelik Grisi Kombine
90611080



Su Yeşilli-Granit Yeşilli Kombine
90611081



Bulut Grisi-Fırtına Mavisi Kombine
90611082



Saten Dore-Tropik Kahve Kombine
90611083

Ürün Ölçüleri

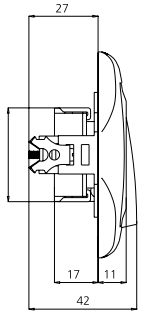
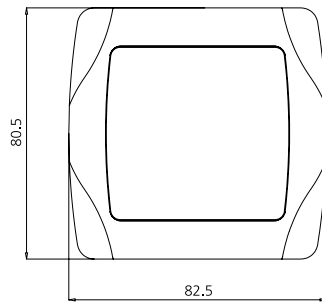



Anahtar
9054XX01



Işıklı Anahtar
9054XX19



Light
9054XX03



Işıklı Light
9054XX14



Kapı Otomatığı
9054XX05



Zil Anahtarı
9054XX06



Işıklı Etiketli Zil
9054XX27



Permütatör (Ara Veavien)
9054XX31



Veavien
9054XX04



Işıklı Veavien
9054XX63



Komütatör Veavien
9054XX17



Komütatör
9054XX02



Işıklı Komütatör
9054XX50



Uçlu Anahtar
9054XX68



Tek Düğmeli Jaluzi Anahtarı
9054XX72



Jaluzi Kumanda Anahtar
9054XX16



600W RL Dimmer
9054XX20



1000W RL Dimmer
9054XX69



400W RC Dimmer
9054XX90



Veavien Dimmer
9054XX40



Dokunmatik Dimmer
9054XX76



Müzik Yayın Anahtarı
9054XX54
9054XX80 (Trafolu)
9054XX91 (Acil Anonlu Trafolu)



Kanal Seçme Anahtarı
9054XX82



Priz
9054XX07



Çocuk Korumalı Priz
9054XX43



Topraklı Priz
9054XX08



Çocuk Korumalı Topraklı Priz
9054XX42



Çocuk Korumalı UPS Priz
9054XX45



Ikili Priz
9054XX55



Ikili Topraklı Priz
9054XX56



Çocuk Korumalı İkili UPS Priz
9054XX57



Çocuk Korumalı Kapaklı Topraklı Priz
9054XX12



TV Priz
9054XX10 (Sonlu)
9054XX60 (Geçişli)
9054XX49 (Direncsiz)



TV Radyo Priz (TV-RD)
9054XX21 (Sonlu)
9054XX22-24 (Geçişli)



Uydu Priz F Konnektörlü
9054XX96 (Sonlu)
9054XX97 (Geçişli 10dB)



TV Uydu Priz (TV-SAT)
9054XX85 (Sonlu)
9054XX86-87 (Geçişli)



TV Radyo Uydu Priz (SAT-TV-RD)
9054XX41 (Sonlu)
9054XX52 (Geçişli)



İkili Uydu Priz (SAT-SAT-TV-RD)
9054XX53



Müzik Yayın Priz
9054XX37



Telefon Priz
9054XX11



Nümeris Telefon Priz (RJ11)
9054XX13



İkili Nümeris Telefon Priz (2 x RJ11)
9054XX33



Data-Nümeris Telefon Priz (RJ45-RJ11)
9054XX35 (Cat5E)
9054XX95 (Cat6)



Data Priz Jaksız
9054X132



Tekli Data Priz (RJ45)
9054XX32 (Cat5E)
9054X332 (Cat6)



İkili Data Priz (2 x RJ45)
9054XX34 (Cat5E)
9054X334 (Cat6)



Energy Saver-Standart (Röle Hariç)
9054X051
90551152 (Logolu Anahtarlık)



Kablo Çıkış Kapağı
9054XX77



Energy Saver Kartlı (Röle Hariç)
9054X065
90551163 (Kart)
9054X0** RF



Kardelen

Zarif bir dokunuş





Kardelen



Ana Renkler



Beyaz



Krem

VİKO, Kardelen serisi ile konfor, estetik ve ahenk kavramlarını hayatın baş köşesine yerleştiriyor.

Kardelen saf güzelliğiyle girdiği mekanlara tıpkı bir ışık perisi gibi dokunuyor. Anahtardan uydu prizine zengin ürün yelpazesine ve çoklu çerçeve opsiyonuna sahip olan Kardelen, beyaz ve krem ana renkleriyle kombinlenebilecek 16 kordon rengiyle sunuluyor.

Sıva Üstü Kasalar



Sıva Üstü Beyaz



Sıva Üstü Krem



Sıva Üstü Beyaz Kasa
90501930



Sıva Üstü Krem kasa
90503930

Sıva üstü kullanımlar için, sıva üstü kasalar en ideal çözümü sunmaktadır. Kardelen ürün grubuna ait bütün ürünler sıva üstü kasaları ile birlikte kullanılabilir.

Yatay Çerçeveler



İkili Çerçeve
9050Y922
(162 x 80 mm)



Üçlü Çerçeve
9050Y923
(223 x 80 mm)



Dörtlü Çerçeve
9050Y924
(294 x 80 mm)



Beşli Çerçeve
9050Y925
(365 x 80 mm)



Altılı Çerçeve
9050Y926
(436 x 80 mm)

Kardelen beyaz ve krem çerçeve seçenekleri;
ikili, üçlü, dörtlü, beşli ve altılı uygulama çözümleri sunmaktadır.

Kordon Renkleri



Beyaz
90601301



Krem
90603701



Gri
90601101



Krom Kaplama
90603601



Altın Yıldız
90601201



Gümüş
90601601



Maun
90601401



Ceviz
90601901



Su Yeşili
90605501



Nil Yeşili
90605201



Kum
90605401



Somon
90605001



Mavi
90603201



Pembe
90603501



Gül
90601701

Ürün Ölçüleri

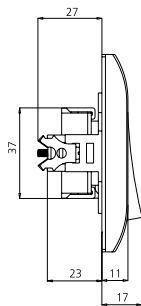
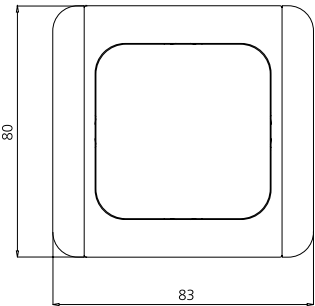



Anahtar
9055X001



Işıklı Anahtar
9055X019



Light
9055X003



Işıklı Light
9055X014



Kapı Otomatığı
9055X005



Zil Anahtarı
9055X006



Işıklı Etiketli Zil
9055XX27



Permütatör (Ara Veavien)
9055X031



Veavien
9055X004



Işıklı Veavien
9055X063



Komütatör Veavien
9055X017



Komütatör
9055X002



Işıklı Komütatör
9055X050



Tek Düğmeli Jaluzi Anahtarı
9055X072



Jaluzi Kumanda Anahtarı
9055X016



600W RL Dimmer
9055X020



1000W RL Dimmer
9055X069



400W RC Dimmer
9055X090



Veavien Dimmer RL
9055X040



Müzik Yayın Anahtarı
9055X054
9055X080 (Trafolu)
9055X091 (Acil Anonslu Trafolu)



Kanal Seçme Anahtarı
9055X082



Priz
9055X007



Çocuk Korumalı Priz
9055X043



Topraklı Priz
9055X008



Çocuk Korumalı Topraklı Priz
9055X042



Çocuk Korumalı UPS Priz
9055X045



Çocuk Korumalı Kapaklı Topraklı Priz
9055X012



İkili Priz
9055X055



İkili Topraklı Priz
9055X056



Cocuk Korumalı İkil UPS Topraklı Priz
9055X057



TV Prizi
9055X010 (Sonlu)
9055X060 (Geçişli)
9055X049 (Dirençsiz)



TV Radyo Prizi (TV-RD)
9055X021 (Sonlu)
9055X022-25 (Geçişli)



Uydu Priz F Konnektörü
9055X096 (Sonlu)
9054X097 (Geçişli 10 dB)



TV Radyo Prizi (TV-SAT)
9055X085 (Sonlu)
9054X086-87 (Geçişli)



TV Uydu Prizi (SAT-TV-RD)
9055X041 (Sonlu)
9055X052 (Geçişli)



İkil Uydu Prizi (SAT-SAT-TV-RD)
9055X053



Müzik Yayın Prizi
9055X037



Telefon Prizi
9055X011



Nümeris Telefon Prizi (RJ11)
9055X013



İkil Nümeris Telefon Prizi (2xRJ11)
9055X033



Data-Nümeris Telefon Prizi (RJ45-RJ11)
9055X035 (Cat5E)
9055X335 (Cat6)



Data Prizi Jaksız
9055X132



Tekli Data Prizi (RJ45)
9055X032 (Cat5E)
9055X332 (Cat6)



İkil Data Prizi (2 x RJ45)
9055X034 (Cat5E)
9055X334 (Cat6)



Kablo Çıkış Kapağı
9055X077



Energy Saver Standart (Röle Hariç)
9055X051
90551152 (Logolu Anahtarlık)



Energy Saver Kartlı (Röle Hariç)
9055X065
90551163 (Kart)
9055X0** RF



Yasemin

İçten dışa mutluluk





Yasemin



Ana Renkler



Beyaz



Krem

Yasemin serisi ile artık mekanların yeni bir etki noktası var. Tarz yaratan renk uyumu ve monotonluğu kıran bütünsel bir ahenk için tasarlanan Yasemin, çerçeve içinde çerçeve, şıklık içinde şıklık olarak tanımlanıyor. Beyaz ve krem alternatifine sahip gövde, 16 çeşit tekli ve ikili kordon seçeneğiyle Yasemin serisi imaja öncelik tanıyanlara, geniş ürün yelpazesi arasından tercih yapma lüksünü sunuyor.

Sıva Üstü Kasalar



Sıva Üstü Beyaz



Sıva Üstü Krem



Sıva Üstü Beyaz Kasa
90502930



Sıva Üstü Krem kasa
90504930

Sıva üstü kullanımlar için, sıva üstü kasalar en ideal çözümü sunmaktadır. Kardelen ürün grubuna ait bütün ürünler sıva üstü kasaları ile birlikte kullanılabilir.

Yatay Çerçeveler



İkili Yatay Çerçeve
9050Y922
(151 x 84 mm)



Üçlü Yatay Çerçeve
9050Y923
(222 x 84 mm)



Dörtlü Yatay Çerçeve
9050Y924
(293 x 84 mm)



Beşli Yatay Çerçeve
9050Y925
(364 x 84 mm)



Altılı Yatay Çerçeve
9050Y926
(435 x 84 mm)

Yasemin beyaz ve krem çerçeve seçenekleri;
ikili, üçlü, dörtlü, beşli ve altılı yatay ve
dikey uygulama çözümleri sunmaktadır.

Tekli Kordon Renkleri



Beyaz 90602201 **Krem** 90604701 **Gri** 90602101 **Krom Kaplama** 90604601



Gümüş 90602501 **Maun** 90602301 **Ceviz** 90602801 **Gül** 90602601



Nil Yeşil 90606201 **Kum** 90606401 **Somon** 90606001 **Mavi** 90604201



Pembe 90604501 **Altın Yıldız** 90602001 **Su Yeşil** 90606501

İkili Priz Kordon Renkleri



Beyaz 90614201 **Krem** 90615701 **Gri** 90614101 **Krom Kaplama** 90615601



Gümüş 90614501 **Maun** 90614301 **Ceviz** 90614801 **Gül** 90614601



Nil Yeşil 90616201 **Kum** 90616401 **Somon** 90616001 **Mavi** 90615201



Pembe 90615501 **Altın Yıldız** 90614001 **Su Yeşil** 90606501

Ürün Ölçüleri

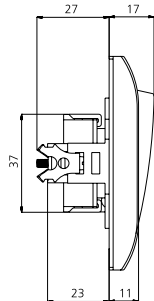
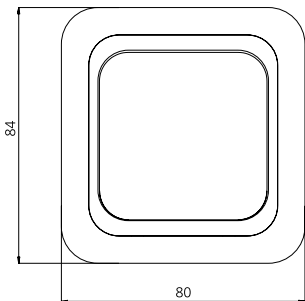



Anahtar
9055X001



Iřıklı Anahtar
9055X019



Light
9055X003



Iřıklı Light
9055X014



Kapı Otomatığı
9055X005



Zil Anahtarı
9055X006



Iřıklı Etiketli Zil
9055X027



Permütatör (Ara Veavien)
9055X031



Veavien
9055X004



Iřıklı Veavien
9055X063



Komütatör Veavien
9055X017



Komütatör
9055X002



Iřıklı Komütatör
9055X050



Üçlü Anahtar
9055X068



Tek Düğmeli Jaluzi Anahtarı
9055X072



Jaluzi Kumanda Anahtarı
9055X016



600W RL Dimmer
9055X020



1000W RL Dimmer
9055X069



400W RC Dimmer
9055X090



Veavien Dimmer RL
9055X040



Müzik Yayın Anahtarı
9055X054
9055X080 (Trafolu)
9055X091 (Acil Anonlu Trafolu)



Kanal Seçme Anahtarı
9055X082



Priz
9055X007



Çocuk Korumalı Priz
9055X043



Topraklı Priz
9055X008



Çocuk Korumalı Topraklı Priz
9055X042



Çocuk Korumalı UPS Priz
9055X045



Çocuk Korumalı Kapaklı Topraklı Priz
9055X012



İkili Priz
9055X055



İkili Topraklı Priz
9055X056



Çocuk Korumalı İkili UPS Topraklı Priz
9055X057



TV Priz
9055X010 (Sonlu)
9055X060 (Geçişli)
9055X049 (Dirençsiz)



TV Radyo Priz (TV-RD)
9055X021 (Sonlu)
9055X022-25 (Geçişli)



Uydu Priz F Konnektörlü
9055X096 (Sonlu)
9055X097 (Geçişli 10 dB)



TV Uydu Priz (SAT-TV)
9055X085 (Sonlu)
9055X086-87 (Geçişli)



İkili Uydu Priz (SAT-SAT-TV-RD)
9055X041 (Sonlu)
9055X052 (Geçişli)



İkili Uydu Priz (SAT-SAT-TV-RD)
9055X053



Müzik Yayın Priz
9055X037



Telefon Priz
9055X011



Nümeris Telefon Priz (RJ11)
9055X013



İkili Nümeris Telefon Priz (2xRJ11)
9055X033



Data-Nümeris Telefon Priz (RJ45-RJ11)
9055X035 (Cat5E)
9055X335 (Cat6)



Data Priz Jaksız
9055X132



Tekli Data Priz (RJ45)
9055X032 (Cat5E)
9055X332 (Cat6)



İkili Data Priz (2 x RJ45)
9055X034 (Cat5E)
9055X334 (Cat6)



Kablo Çıkış Kapağı
9055X077



Energy Saver Standart (Röle Hariç)
9055X051
90551152 (Logolu Anahtarlık)



Energy Saver Kartlı (Röle Hariç)
9055X065
90551163 (Kart)
9055X0** RF ID



Vera
sıva üstü
IP20



Güvenlik noktası



Vera sıva üstü IP20



Ana Renkler



Beyaz



Krem



Maun



Meşe

Vera sıva üstü serisi, yüksek kullanım güvenliği için tam gereken standartlara sahip. Konfor, tasarım, işlevsellik beklentilerini kusursuzca yanıtlayan Vera, beyaz, krem ve ahşap görünüm renk seçenekleri ve dayanıklı yapısıyla en zorlu mekanlarda dahi sağlam bir duruş sergiliyor. Geniş ürün yelpazesine kolay monte edilebilme özelliği sayesinde ise kullanım alanlarının her ihtiyacını karşılıyor.



Anahtar
9068XX01



Işıklı Anahtar
9068XX19



Light
9068XX03



Üçlü Anahtar
9068XX68



Işıklı Etiketli Zil
9068XX27



Veavien
9068XX04



Işıklı Veavien
9068XX63



Komütatör Veavien
9068XX17



Komütatör
9068XX02



Işıklı Komütatör
9068XX50



Priz
9068XX07



Topraklı Priz
9068XX08



UPS Toprak Priz
9068XX45



İkili Priz
9068XX55



İkili Topraklı Priz
9068XX56



TV Priz
9068XXXX (Sonlu)
9068XX59 (Geçişli 8dB)
9068XX60 (Geçişli 12dB)
9068XX61 (Geçişli 18dB)
9068XX49 (Direncsiz)



Tekli Nümeris Cat 3
9068XX13



Tekli Data Cat 5
9068XX32



Dikey Kombinasyon



Anahtar + Priz
9068XY86



Işıklı Anahtar + Priz
9068XY90



Veavien + Priz
9068XY91



Komütatör + Priz
9068XY89

Yatay Kombinasyon



Anahtar + Priz
9068XY86



Işıklı Anahtar + Priz
9068XY90



Veavien + Priz
9068XY91



Komütatör + Priz
9068XY89

Ürün Ölçüleri

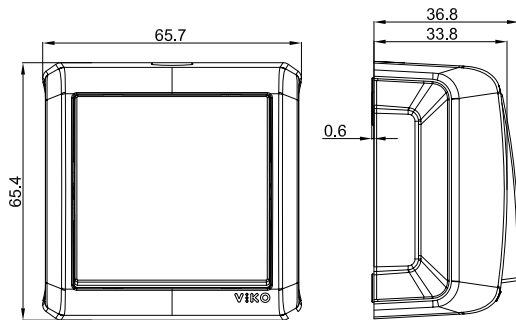

XY KODUNUN KARŞILIĞI: 10 = Dikey Beyaz 20 = Dikey Meşe
11 = Yatay Beyaz 21 = Yatay Meşe
12 = Dikey Krem 22 = Dikey Maun
13 = Yatay Krem 23 = Yatay Maun

Montaj Şekli

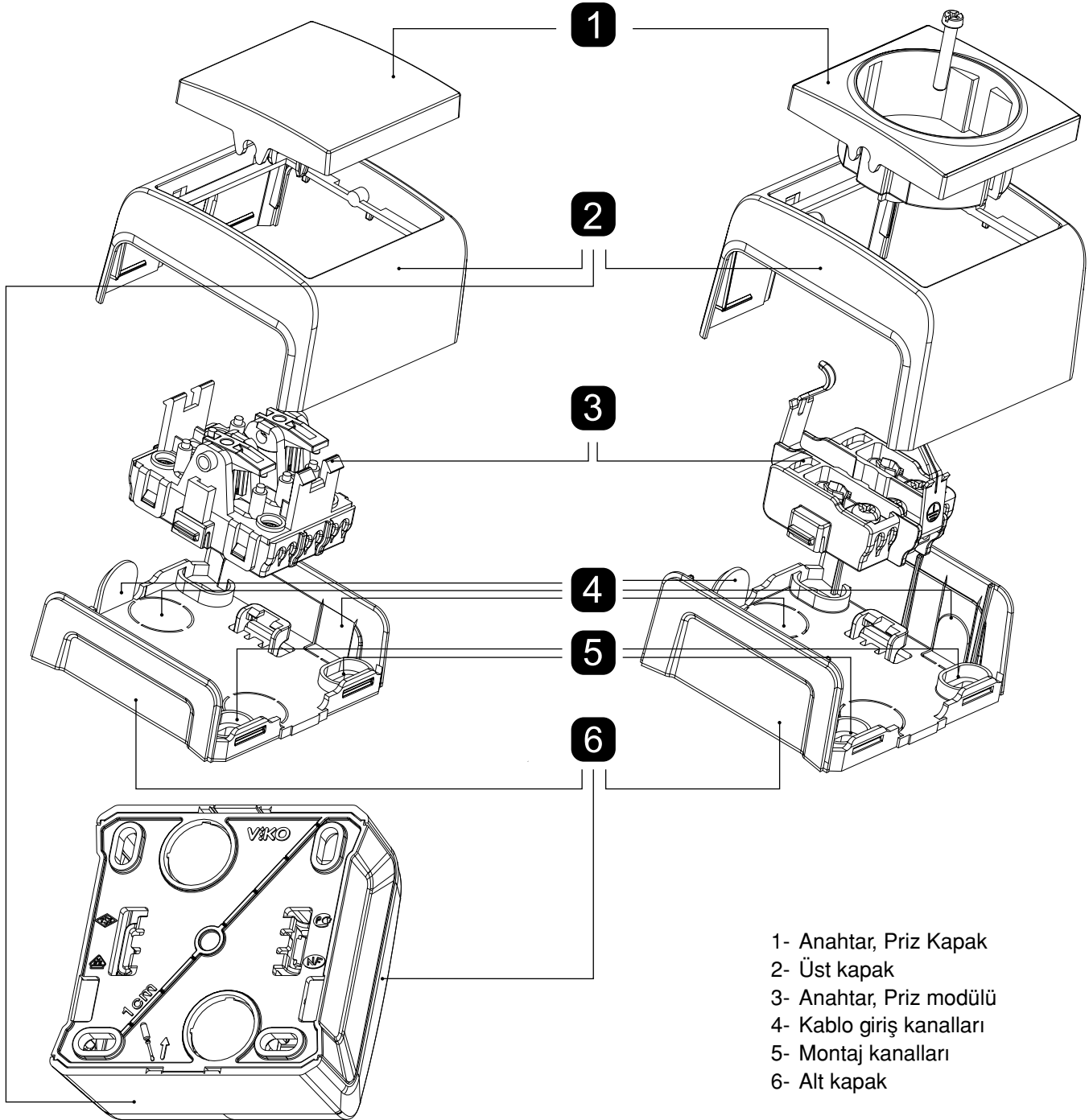

Priz için öncelikle üst kapak üzerindeki vidayı gevşetin.

Alt kapakta yer alan (6) tornavida ucu için uygun girintiyi kullanarak tornavida yardımı ile alt kapağı üst kapaktan ayırın, üst kapağı (2) çekerek çıkartın. Ürüne kablo montajı için (4) uygun

olan belirlemiş kablo çıkış kanallarını üründen ayırarak kablo montajı için uygun hale getirin.

Ürünün duvara montajı için açılmış kanallardan (5) vida ile duvara montajını gerçekleştirin.

Modülü (3) uygun şekilde montaj yaptıktan sonra, üst kapağı (2) geçmeli kanallardan tutturmak suretiyle kapatarak, en son ürünün anahtar düğme yada priz kapağını (1) yerine takarak montajı tamamlayın.



Palmiye
nemli yer serisi
IP54

Tozlu ve nemli mekanların ayrıcalığı





Palmiye nemli yer serisi IP54



Ana Renkler



Beyaz



Krem



Gri

Daha fazla dikkat ve özen isteyen alanlar şimdi IP 54 özellikli Palmiye serisinin ayrıcalığını yaşıyor. Nemli ve tozlu mekanlarda Palmiye serisi güvenlik duygusunun çitasını yükseltiyor. Yatay ve dikey olarak kombine edilebilen Palmiye serisi ürünleri uzun ömür ve dayanıklılık özelliğiyle öne çıkarken, krem ve gri renk seçenekleri dekoratif olarak tercih yapma olanağı sağlıyor.

Renk Seçenekleri

Beyaz



Krem



Gri



Ürün Ölçüleri

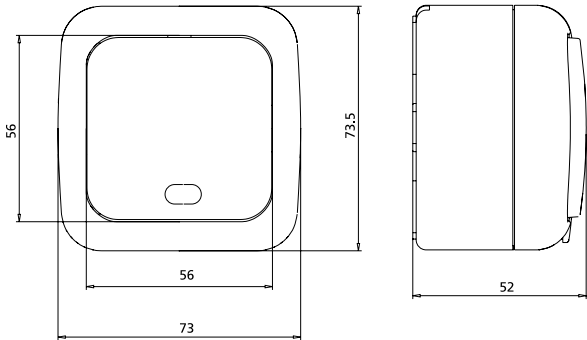

Palmye serisi bütün ürünler için beyaz, gri ve krem renk seçenekleri sunmaktadır.

Palmye serisini farklı yapan üstün özellikler

- IP 54 özelliği sayesinde toza ve neme karşı dayanıklılık ve uzun ömürlü.
- Kapak, sadece vidayı çevirerek sökmeden monte ve demonte edilir.
- Kabloyu bastırarak monte etme imkanı sağlayan esnek conta sistemi.
- Hızlı bağlantı sistemiyle çabuk ve emniyetli kablolama.



Anahtar
9055XX01



Işıklı Anahtar
9055XX19



Light
9055XX03



Işıklı Light
9055XX14



Kapı Otomatığı
9055XX05



Zil Anahtar
9055XX06



Işıklı Etiketli Zil
9055XX27



Permütatör (Ara Veavien)
9055XX31



Veavien
9055XX04



Işıklı Veavien
9055XX63



Komütatör Veavien
9055XX17



Komütatör
9055XX02



Topraklı Priz
9055XX08



UPS Topraklı Priz
9055XX15



TV Priz
9055XX10 (Sonlu)
9055XX60 (Geçişli)
9055XX49 (Direncsiz)



Nümeris Telefon Prizi (RJ11)
9055XX13

Yatay Kombinasyon



Anahtar - Topraklı Priz
9055XX81



Işıklı Anahtar - Topraklı Priz
9055XX99



Light - Topraklı Priz
9055XX83



Işıklı Light - Topraklı Priz
9055XX94



Veavien - Topraklı Priz
9055XX84



Işıklı Veavien - Topraklı Priz
9055XX93



Komütatör Veavien - Topraklı Priz
9055XX87



Komütatör - Topraklı Priz
9055XX82



Topraklı Priz - Topraklı Priz
9055XX88

Dikey Kombinasyon



Anahtar - Topraklı Priz
9055YY81



Işıklı Light - Topraklı Priz
9055YY84



Işıklı Veavien - Topraklı Priz
9055YY83



Veavien - Topraklı Priz
9055YY89



Işıklı Light - UPS Topraklı Priz
9055YY92



Light - Topraklı Priz
9055YY83



Komütatör Veavien - Topraklı Priz
9055YY90



Komütatör - Topraklı Priz
9055YY82



Topraklı Priz - Topraklı Priz
9055YY91

İsteğinize Uygun Yatay ve Dikey İkili Kombine Seçenekleri!

Dilediğiniz ürünleri seçerek ihtiyaçlarınıza uygun yeni kombinasyonlar oluşturabilirsiniz.



Sigorta
Kutuları



Sigorta Kutuları



Bugün hemen her noktada aynı anda talep edilen iki kavram, güvenlik ve tasarım, VIKO sigorta kutularında buluştu. Plastiğin yalıtıncılığıyla hassas güvenlik, estetik hatlarıyla dekoratif duruş VIKO sigorta kutularında bir arada ve hayatın içinde. Diğer yandan dayanıklı yapısıyla ısıya ve darbelere karşı direnç gösteren sigorta kutuları, geniş iç hacmiyle de çalışma rahatlığı beklentilerini en iyi şekilde karşılıyor.

Ürün Özellikleri

VIKO sigorta kutuları; plastiğin yalıtıncılığıyla güvenlik, seçkin tasarımıyla da estetik bir görünüm sağlıyor. Isıya ve darbeye karşı dayanıklı yapısı ve çalışma rahatlığı sağlayan geniş iç hacmi sayesinde de beklentilerinizi fazlasıyla karşılıyor.

- IP40 Koruma standardına uygundur.
- Sınıf II; elektrik çarpmasına karşı korumalıdır.
- Tesis sırasındaki sıcaklık aralığı -15°C / + 60°C.
- 650°C'ye kadar alev ve yanmaya karşı dayanıklıdır.
- Kullanım yerine göre 180°C çevrilerek takılabilen kapaklara sahiptir.
- Çerçevenin yaylı olması cam kapağının açık kalmasını sağlar.
- Sigorta rayı galvanizli sacdan imal edilmiştir.
- Geniş iç hacmi sayesinde montaj ve çalışma rahatlığı sağlar.
- Isıya ve darbelere karşı dayanıklıdır.
- Topraklama klemensi ve bağlantı aksesuarları mevcuttur.
- Yalıtımı topraklamayla bağlama opsiyonu.
- Halojensiz opsiyonu.
- Montaj hassasiyeti sağlayan su terazisi.



IP 40



Klemens



4'lü Klemens
90910001



6'lü Klemens
90910002



9'lü Klemens
90910003



10'lü Klemens
90910004



12'lü Klemens
90910005



6'lü İzole Klemens
90911002



10'lü İzole Klemens
90911005



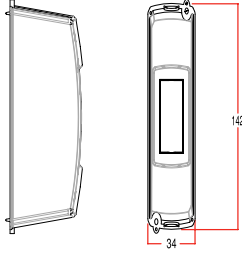
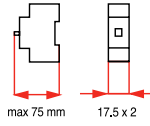

1'li Sıva Üstü
90914000



1-2'li Sıva Üstü
90914001

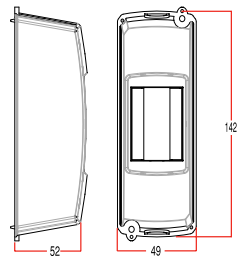
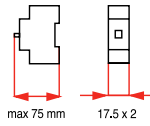



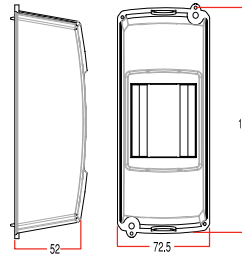
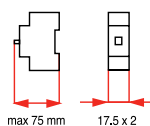

3-4'lü Sıva Üstü
90914003

2'li Sıva Altı
90912002

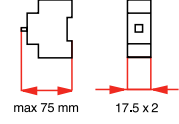
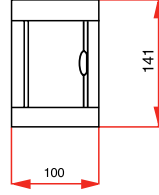
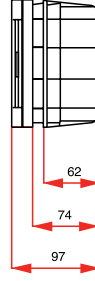

4'lü Sıva Altı
90912004

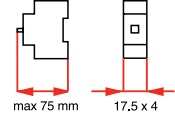
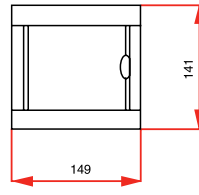
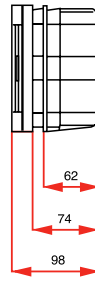

6'lı Sıva Altı
90912006

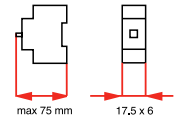
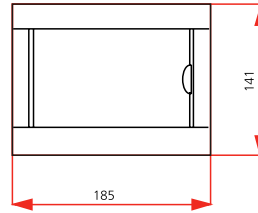
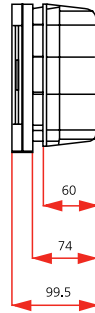

8'li Sıva Altı
90912008



Kilitli kapak sistemi.

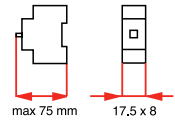
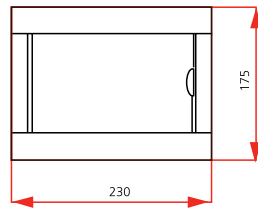



12'li Sıva Altı
90912012

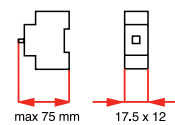
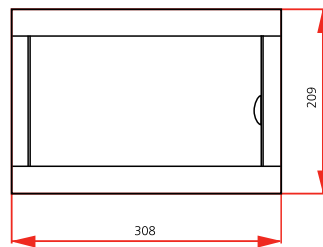
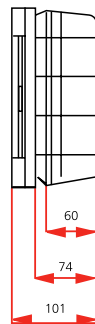

Kilitli kapak sistemi.





16'lı Sıva Altı
90912016

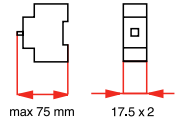
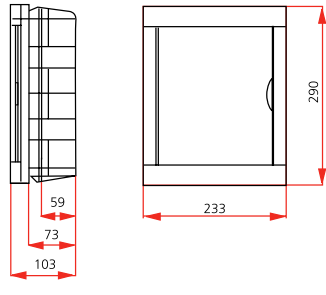

Kilitli kapak sistemi.



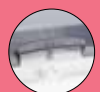

18'li Sıva Altı
90912018

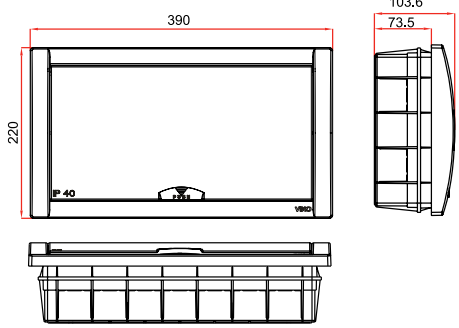

Kilitli kapak sistemi.





24'lü Sıva Altı
90912024

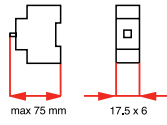
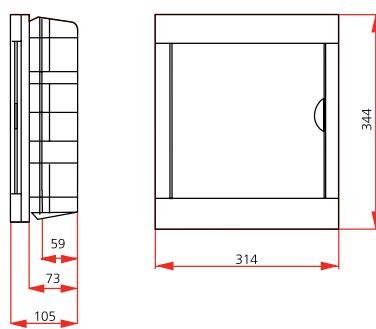

Kilitli kapak sistemi.



36'li Sıva Altı
90912036



Kilitli kapak sistemi.

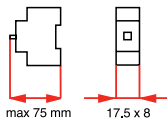
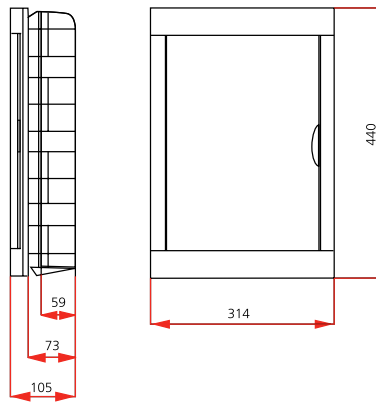



2'li Sıva Üstü
90912102

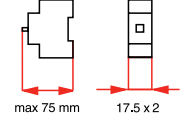
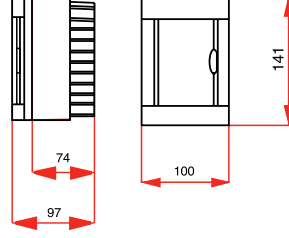

4'lü Sıva Üstü
90912104

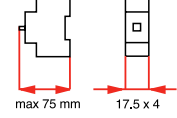
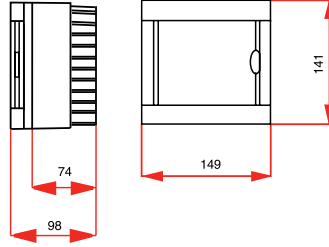

6'lı Sıva Üstü
90912106

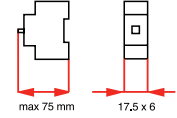
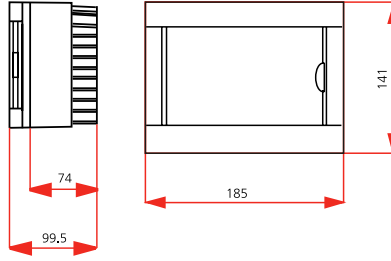

8'li Sıva Üstü
90912108



Kilitli kapak sistemi.

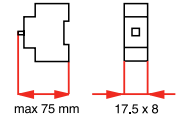
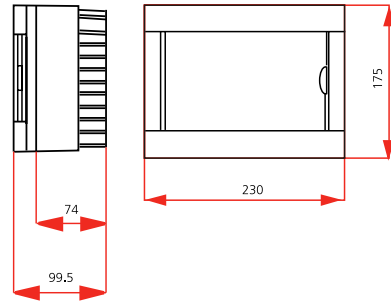



12'li Sıva Üstü
90912112

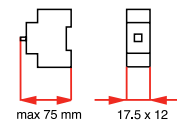
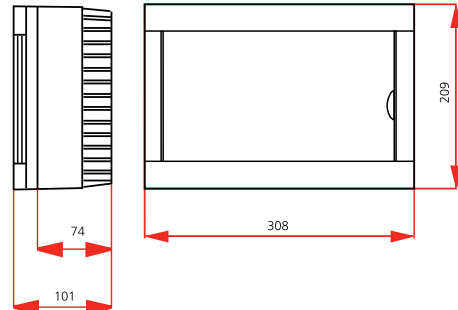

Kilitli kapak sistemi.





16'lı Sıva Üstü
90912116

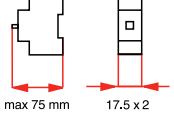
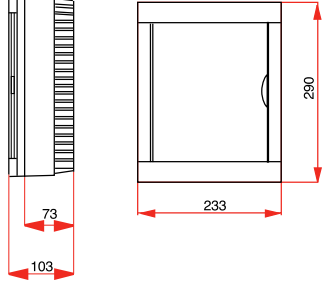

Kilitli kapak sistemi.





18'li Sıva Üstü
90912118

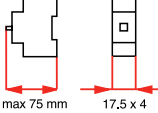
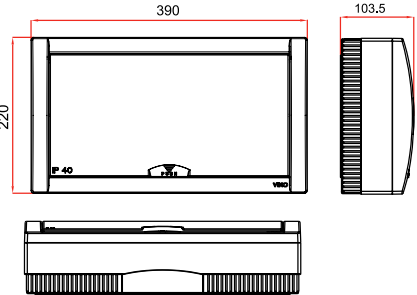

Kilitli kapak sistemi.





24'lü Sıva Üstü
90912124

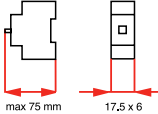
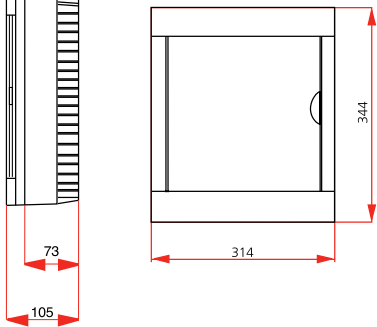

Kilitli kapak sistemi.



36'li Sıva Üstü
90912136



Kilitli kapak sistemi.

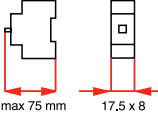
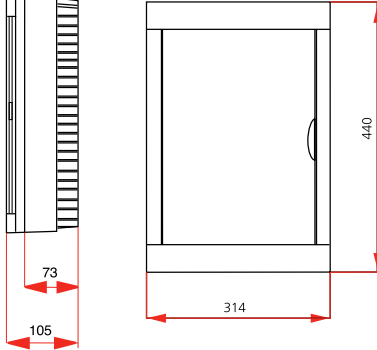



Grup Priz ve
Aksesuarlar
IP40





Grup Priz ve Aksesuarlar IP40



Leylak



Beyaz



Siyah

Lale



Beyaz

İhtiyaçların sınırsız olduğu ve ancak esnek çözümlerle memnuniyete ulaşılan bir dönemde yaşıyoruz. VİKO grup prizler ve aksesuarlar işte bu anlayışla tasarlanıp üretiliyor. Dayanıklı gövdeleri ve kaliteli iç yapılarıyla her VİKO ürünü yaşam alanlarıyla bütünleşiyor.

İkili Topraklı Priz



Klemensli
90207700 90207750 (Siyah)



Kablolu
90107600 (2 m) 90107646 (2 m) (Siyah)
90107603 (3 m) 90107643 (3 m) (Siyah)
90107605 (5 m) 90107645 (5 m) (Siyah)



Anahtarlı Klemensli
90207720 90207752 (Siyah)



Anahtarlı Kablolu
90107620 (2 m) 90107656 (2 m) (Siyah)
90107623 (3 m) 90107653 (3 m) (Siyah)
90107625 (5 m) 90107655 (5 m) (Siyah)



Klemensli-UPS
90207704 90207751 (Siyah)



Kablolu-UPS
90107604 (2 m) 90107644 (2 m) (Siyah)



Anahtarlı Klemensli-UPS
90207724 90207753 (Siyah)



Anahtarlı Kablolu-UPS
90107624 (2 m) 90107638 (2 m) (Siyah)

Üçlü Topraklı Priz



Klemensli
90207900 90207946 (Siyah)



Kablolu
90107800 (2 m) 90107846 (2 m) (Siyah)
90107803 (3 m) 90107843 (3 m) (Siyah)
90107805 (5 m) 90107845 (5 m) (Siyah)



Anahtarlı Klemensli
90207920 90207956 (Siyah)



Anahtarlı Kablolu
90107820 (2 m) 90107856 (2 m) (Siyah)
90107823 (3 m) 90107853 (3 m) (Siyah)
90107825 (5 m) 90107855 (5 m) (Siyah)



Klemensli-UPS
90207904 90207951 (Siyah)



Kablolu-UPS
90107804 (2 m) 90107844 (2 m) (Siyah)



Anahtarlı Klemensli-UPS
90207924 90207953 (Siyah)



Anahtarlı Kablolu-UPS
90107824 (2 m) 90107837 (2 m) (Siyah)

Dörtlü Topraklı Priz



Klemensli
90208100 90208150 (Siyah)



Anahtarlı Klemensli
90208120 90208152 (Siyah)



Kablolu
90108000 (2 m) 90108046 (2 m) (Siyah)
90108003 (3 m) 90108043 (3 m) (Siyah)
90108005 (5 m) 90108045 (5 m) (Siyah)



Anahtarlı Kablolu
90108020 (2 m) 90108056 (2 m) (Siyah)
90108023 (3 m) 90108053 (3 m) (Siyah)
90108025 (5 m) 90108055 (5 m) (Siyah)



Klemensli-UPS
90208104 90208151 (Siyah)



Anahtarlı Klemensli-UPS
90208124 90208153 (Siyah)



Kablolu-UPS
90108004 (2 m) 90108044 (2 m) (Siyah)



Anahtarlı Kablolu-UPS
90108024 (2 m) 90108038 (2 m) (Siyah)



Beşli Topraklı Priz



Klemensli
90208500 90208550 (Siyah)



Anahtarlı Klemensli
90208520 90208537 (Siyah)



Kablolu
90108400 (2 m) 90108446 (2 m) (Siyah)
90108403 (3 m) 90108443 (3 m) (Siyah)
90108405 (5 m) 90108445 (5 m) (Siyah)



Anahtarlı Kablolu
90108420 (2 m) 90108456 (2 m) (Siyah)
90108423 (3 m) 90108453 (3 m) (Siyah)
90108425 (5 m) 90108455 (5 m) (Siyah)



Klemensli-UPS
90208504 90208551 (Siyah)



Anahtarlı Klemensli-UPS
90208524 90208553 (Siyah)



Kablolu-UPS
90108404 (2 m) 90108444 (2 m) (Siyah)



Anahtarlı Kablolu-UPS
90108424 (2 m) 90108438 (2 m) (Siyah)

Altılı Topraklı Priz



Klemensli
90208300 90208346 (Siyah)



Anahtarlı Klemensli
90208320 90208352 (Siyah)



Kablolu
90108200 (2 m) 90108246 (2 m) (Siyah)
90108203 (3 m) 90108243 (3 m) (Siyah)
90108205 (5 m) 90108245 (5 m) (Siyah)



Anahtarlı Kablolu
90108220 (2 m) 90108256 (2 m) (Siyah)
90108223 (3 m) 90108253 (3 m) (Siyah)
90108225 (5 m) 90108255 (5 m) (Siyah)

Altılı Topraklı Priz



Klemensli-UPS
90208304 90208351 (Siyah)



Anahtarlı Klemensli-UPS
90208324 90208353 (Siyah)



Kablolu-UPS
90108204 (2 m) 90108244 (2 m) (Siyah)



Anahtarlı Kablolu-UPS
90108224 (2 m) 90108238 (2 m) (Siyah)

Topraksız Priz



Klemensli
90208700 90208702 (Siyah)



Klemensli
90208900 90208902 (Siyah)



Kablolu
90108600 (2 m) 90108630 (2 m) (Siyah)
90108603 (3 m) 90108631 (3 m) (Siyah)
90108605 (5 m) 90108632 (5 m) (Siyah)



Kablolu
90108800 (2 m) 90108830 (2 m) (Siyah)
90108803 (3 m) 90108831 (3 m) (Siyah)
90108805 (5 m) 90108832 (5 m) (Siyah)



Klemensli
90209100 90209102 (Siyah)



Anahtarlı Klemensli
90208920 90208922 (Siyah)



Kablolu
90109000 (2 m) 90109020 (2 m) (Siyah)
90109003 (3 m) 90109031 (3 m) (Siyah)
90109005 (5 m) 90109032 (5 m) (Siyah)



Anahtarlı Kablolu
90108820 (2 m) 90108833 (2 m) (Siyah)
90108823 (3 m) 90108834 (3 m) (Siyah)
90108825 (5 m) 90108835 (5 m) (Siyah)



Üçlü Topraklı Priz



Klemensli
90205700



Kablolu
90105600 (2 m)
90105603 (3 m)
90105605 (5 m)



Anahtarlı Klemensli
90205720



Anahtarlı Kablolu
90105620 (2 m)
90105623 (3 m)
90105625 (5 m)



Klemensli-UPS
90205704



Kablolu-UPS
90105604 (2 m)



Anahtarlı Klemensli-UPS
90205724



Anahtarlı Kablolu-UPS
90105624 (2 m)

Altılı Topraklı Priz



Klemensli
90205900



Kablolu
90105800 (2 m)
90105803 (3 m)
90105805 (5 m)



Klemensli-UPS
90205904



Kablolu-UPS
90105804 (2 m)



Anahtarlı Klemensli
90205920



Anahtarlı Kablolu
90105820 (2 m)
90105823 (3 m)
90105825 (5 m)



Anahtarlı Klemensli-UPS
90205924



Anahtarlı Kablolu-UPS
90105824 (2 m)

Aksesuarlar



Yonca Siva Altı Topraklı Üçlü Priz
90304000



Yonca Topraklı Üçlü Priz-Fiş
90303000



Siyah Yonca Topraklı Üçlü Priz-Fiş
90303300



Topraklı Dişi Fiş
90301800



Monofaze Dişi Fiş
90302500



Telefon Fişi
90302800



Topraklı Ütü Fişi
90302000



Ütü Fişi
90301900



Monoblok Topraklı Erkek Fiş
90304200



Topraklı Erkek Fiş
90304100



Monoblok UPS Topraklı Erkek Fiş
90304240



Mimoza Erkek Fiş
90305400



Mimoza Erkek Fiş Siyah
90305410



Bakalit Ara Puar
90302700



Uzatıcı Takım
90302100 (3 m)
90302200 (5 m)
90302210 (10 m)



Topraklı Uzatıcı Takım
90302300 (3 m)
90302400 (5 m)
90302410 (10 m)



Alçıpan Kasa
9092600X



Derin Geçmeli Kasa
90926001



Kısa Geçmeli Kasa
90926002





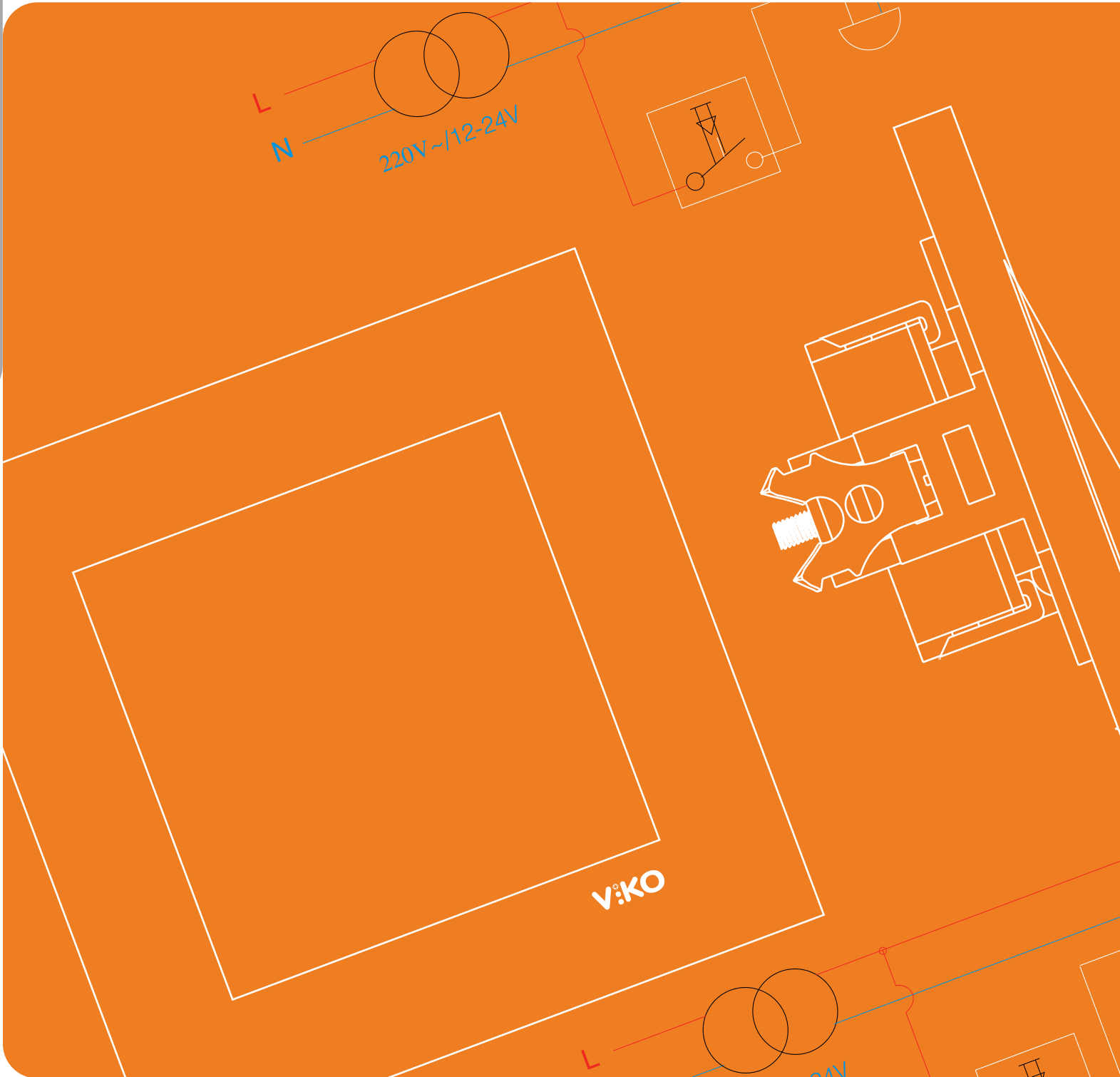



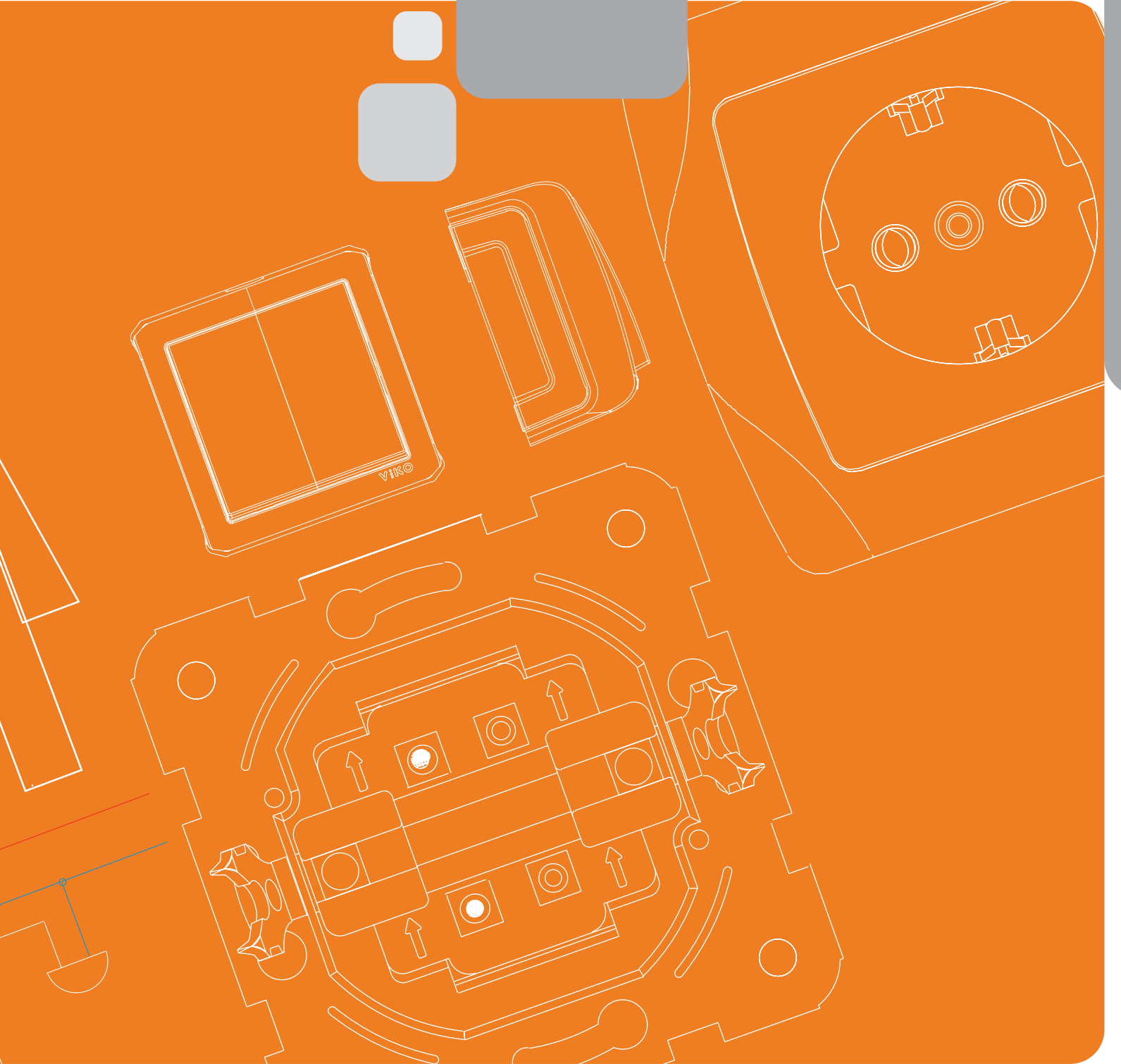

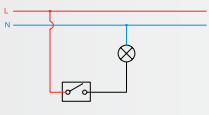
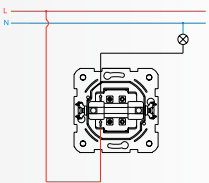

Norm Kasa
90926003

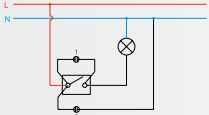
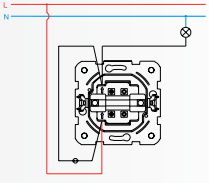

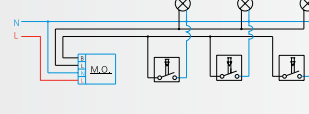
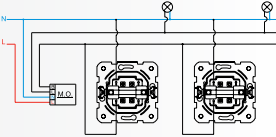
Teknik
Özellikler

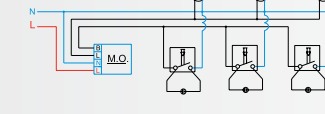
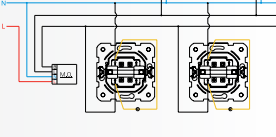

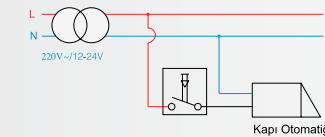
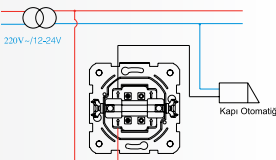

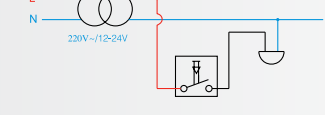
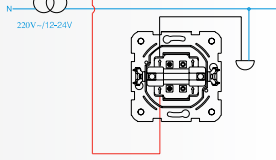

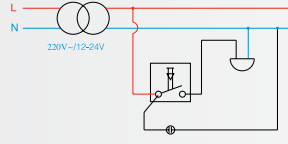
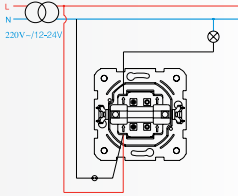
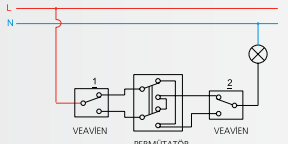
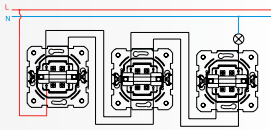
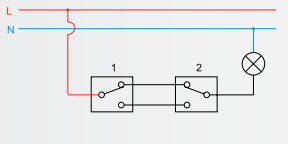
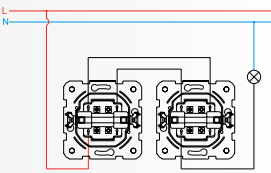
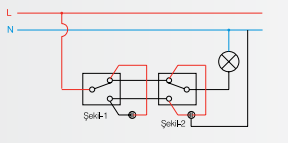
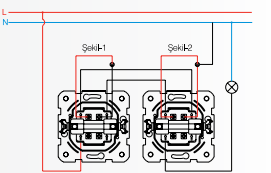
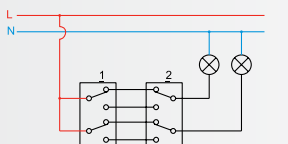
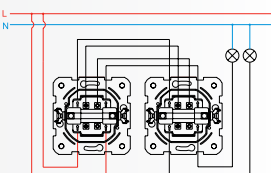









	Teknik Özellikler	Devre Şeması	Bağlantı Şeması
 Anahtar	<ul style="list-style-type: none">• Bir lamba veya lamba grubuna bir yerden kumanda eder.• 10 AX, 250 V~• Bir kutuplu, bir yönlü.• Vidalı veya vidasız (çabuk bağlantılı) montaj seçeneği.		
 Işıklı Anahtar	<ul style="list-style-type: none">• Bir lamba veya lamba grubuna bir yerden kumanda eder.• 10 AX, 250 V~• Bir kutuplu, bir yönlü.• Işıklı.• Vidalı veya vidasız (çabuk bağlantılı) montaj seçeneği.• Neon lamba akımı 0,6 - 1mA.	 <small>1 - Akkor flamanlı (tungsten) lamba için kullanılır 2 - Balast veya trafo içeren aydınlatma ürünleri, tasarruflu ampulleri için kullanılır.</small>	
 Light Anahtarı	<ul style="list-style-type: none">• Bir lamba veya lamba grubuna kumanda eden merdiven otomatığının harekete geçirilmesinde kullanılır.• 10 A, 250 V~• Bir kutuplu, bir yönlü.• Ani basmalı tip.• Vidalı veya vidasız (çabuk bağlantılı) montaj seçeneği.		
 Işıklı Light Anahtarı	<ul style="list-style-type: none">• Bir lamba veya lamba grubuna kumanda eden merdiven otomatığının harekete geçirilmesinde kullanılır.• 10 A, 250 V~• Bir kutuplu, bir yönlü.• Ani basmalı tip.• Işıklı.• Vidalı veya vidasız (çabuk bağlantılı) montaj seçeneği.• Neon lamba akımı 0,6 - 1mA.		
 Kapı Otomatığı Anahtarı	<ul style="list-style-type: none">• Kapı otomatığını kumanda eder.• 10 A, 250 V~• Bir kutuplu, bir yönlü.• Ani basmalı tip.• Vidalı veya vidasız (çabuk bağlantılı) montaj seçeneği.	 Kapı Otomatığı	 Kapı Otomatığı
 Zil Anahtarı	<ul style="list-style-type: none">• Kapı zilini kumanda eder.• 10 A, 250 V~• Bir kutuplu, bir yönlü.• Ani basmalı tip.• Vidalı veya vidasız (çabuk bağlantılı) montaj seçeneği.		



<p>⊗</p> <p>İşıkli Etiketli Zil Anahtarı</p>	<p>Teknik Özellikler</p> <ul style="list-style-type: none"> • Kapı zilini kumanda eder. • 10 A, 250 V~ • Bir kutuplu, bir yollu. • Ani basmalı tip. • İşıkli ve etiketli. • Vidalı veya vidasız (çabuk bağlantılı) montaj seçeneđi. • Neon lamba akımı 0,6 - 1mA. 	<p>Devre Şeması</p> 	<p>Bađlantı Şeması</p> 
<p>⊗</p> <p>Permütatör (Ara Veavien)</p>	<p>Teknik Özellikler</p> <ul style="list-style-type: none"> • Permütatör, bir lamba veya lamba grubuna, ikiden fazla yerden kumanda edilmesini sağlar. • 10 A, 250 V~ • Bir kutuplu, iki yollu. • Vidalı veya vidasız (çabuk bağlantılı) montaj seçeneđi. 	<p>Devre Şeması</p> 	<p>Bađlantı Şeması</p> 
<p>⊗</p> <p>Veavien</p>	<p>Teknik Özellikler</p> <ul style="list-style-type: none"> • Bir lamba veya lamba grubunu iki ayrı noktadan kumanda eder. • 10 AX, 250 V~ • Bir kutuplu, iki yollu. • Vidalı veya vidasız (çabuk bağlantılı) montaj seçeneđi. 	<p>Devre Şeması</p> 	<p>Bađlantı Şeması</p> 
<p>⊗</p> <p>İşıkli Veavien</p>	<p>Teknik Özellikler</p> <ul style="list-style-type: none"> • Bir lamba veya lamba grubunu iki ayrı noktadan kumanda eder. • 10 AX, 250 V~ • Bir kutuplu, iki yollu. • İşıkli. • Vidalı veya vidasız (çabuk bağlantılı) montaj seçeneđi. • Neon lamba akımı 0,6 - 1mA. • Kullanılan neonun üç bacağı olup, tungsten ampul ile birlikte kullanılırken kırmızı uçlardan biri veavien çıkışının birine siyah uç diğer çıkışa bağlanır. (Şekil-1) • Flerosan lamba ile kullanımda neonun kırmızı uçlarından biri veavienin bir çıkışına diğer kırmızı uçta diğer çıkışa bağlanır, siyah olan uç ise nötre bağlanır. (Şekil-2) 	<p>Devre Şeması</p> 	<p>Bađlantı Şeması</p> 
<p>⊗</p> <p>Komütatör Veavien</p>	<p>Teknik Özellikler</p> <ul style="list-style-type: none"> • İki ayrı lamba veya lamba grubuna aynı yerden kumanda eder. • 10 AX, 250 V~ • İki kutuplu, iki yollu. • Vidalı veya vidasız (çabuk bağlantılı) montaj seçeneđi. 	<p>Devre Şeması</p> 	<p>Bađlantı Şeması</p> 



	Teknik Özellikler	Devre Şeması	Bağlantı Şeması												
 Komütatör	<ul style="list-style-type: none">• İki ayrı lamba veya lamba grubuna aynı yerden kumanda eder.• 10 AX, 250 V~• Bir kutuplu, iki yollu.• Vidalı veya vidasız (çabuk bağlantılı) montaj seçeneği.														
 Işıklı Komütatör	<ul style="list-style-type: none">• İki ayrı lamba veya lamba grubuna aynı yerden kumanda eder.• 10 AX, 250 V~• Bir kutuplu, iki yollu.• Işıklı.• Vidalı veya vidasız (çabuk bağlantılı) montaj seçeneği.• Neon lamba akımı 0,6 - 1mA.														
 Üçlü Anahtar	<ul style="list-style-type: none">• Üç ayrı lamba veya lamba grubunu aynı yerden kumanda eder.• 10 AX, 250 V~• Bir kutuplu, üç yollu.• Vidalı veya vidasız (çabuk bağlantılı) montaj seçeneği.														
 Tek Düğmeli Jaluzi Kumanda Anahtarı	<ul style="list-style-type: none">• Jaluzi motorlarının devir yönünü değiştirerek, jaluzinin yukarı ve aşağı yönde hareketini kumanda eder.• 10 A, 250 V~• Bir kutuplu, iki yollu.• Çabuk bağlantı (vidasız) klemensli.														
 Jaluzi Kumanda Anahtarı	<ul style="list-style-type: none">• Jaluzi motorlarının devir yönünü değiştirerek, jaluzinin yukarı ve aşağı yönde hareketini kumanda eder.• 10 A, 250 V~• Bir kutuplu, iki yollu.• Vidalı veya vidasız (çabuk bağlantılı) montaj seçeneği.														
 Rotatif Dimmer 600 W RL	<table border="1"><thead><tr><th></th><th>220 V~ 50-60 Hz</th><th>Min.</th><th>Max.</th></tr></thead><tbody><tr><td> Akkor İlamanlı ve Hubuk halojen lamba</td><td></td><td>60 W</td><td>600 W</td></tr><tr><td> Mekanik trafolu halojen lamba</td><td></td><td>100 W</td><td>450 W</td></tr></tbody></table>		220 V~ 50-60 Hz	Min.	Max.	 Akkor İlamanlı ve Hubuk halojen lamba		60 W	600 W	 Mekanik trafolu halojen lamba		100 W	450 W		
	220 V~ 50-60 Hz	Min.	Max.												
 Akkor İlamanlı ve Hubuk halojen lamba		60 W	600 W												
 Mekanik trafolu halojen lamba		100 W	450 W												

**Rotatif Dimmer
1000 W RL**

Teknik Özellikler

	220 V~ 50-60 Hz	Min.	Max.
 Akkor flamanlı ve Hubuk halojen lamba		100 W	1000 W
 Mekanik trafolu halojen lamba		100 W	800 W

Devre Şeması

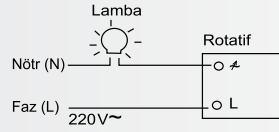

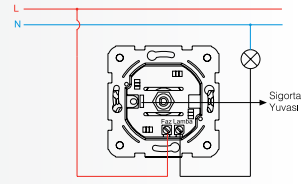

Bağlantı Şeması



**Rotatif Dimmer
400 W RC**

Teknik Özellikler

	220 V~ 50-60 Hz	Min.	Max.
 Akkor flamanlı ve çubuk halojen lamba		60 W	400 W
 Elektronik trafolu halojen lamba		60 W	400 W

Devre Şeması

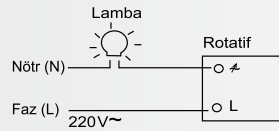

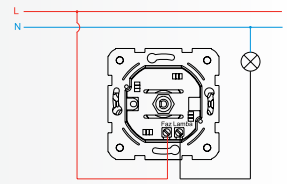

Bağlantı Şeması



Dokunmatik Dimmer RL

Teknik Özellikler

	220 V~ 50-60 Hz	Min.	Max.
 Akkor flamanlı ve çubuk halojen lamba		60 W	500 W
 Mekanik trafolu halojen lamba		100 W	400 W

Devre Şeması

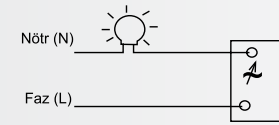

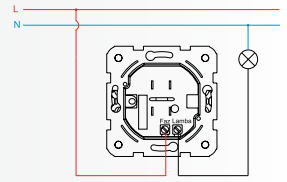

Bağlantı Şeması



Veavien Dimmer RL

Teknik Özellikler

	220 V~ 50-60 Hz	Min.	Max.
 Akkor flamanlı ve çubuk halojen lamba		60 W	500 W
 Mekanik trafolu halojen lamba		100 W	400 W

Devre Şeması

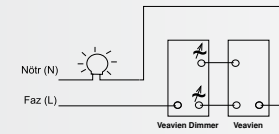

Bağlantı Şeması

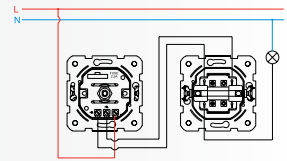

Müzik Yayın Anahtarı

Teknik Özellikler

- 11 kademeli ses ayarı.
- 8 Ω ohmik dirençli ses ayarı.
- 5 W hoparlör girişi.

Devre Şeması

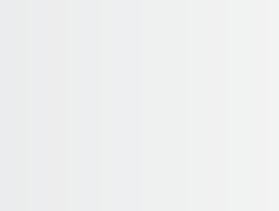

Bağlantı Şeması

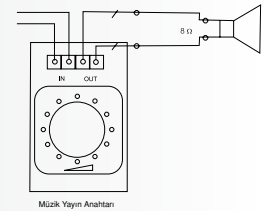

Trafolu Müzik Yayın Anahtarı

Teknik Özellikler

- 11 kademeli ses ayarı.
- 100 V ses sistemleri için.
- 2 VA trafolu
- 4 x 100V hoparlör desteği.



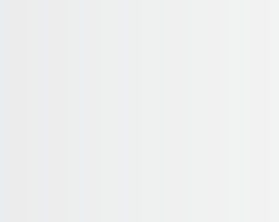



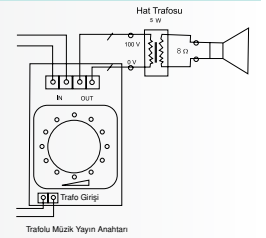

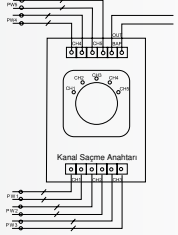

Devre Şeması

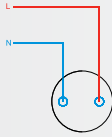
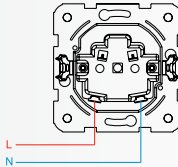

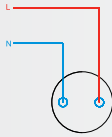
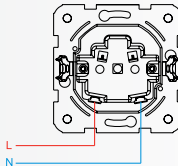

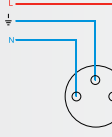
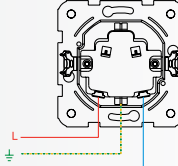

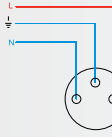
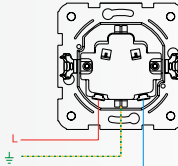

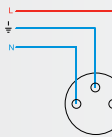
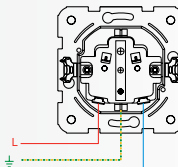

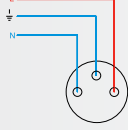
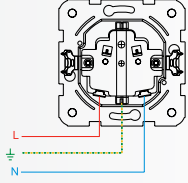
Bağlantı Şeması

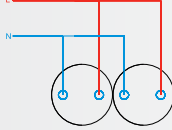
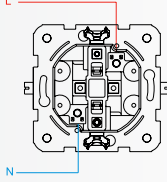

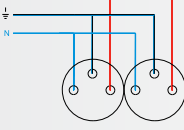
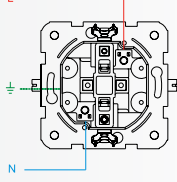

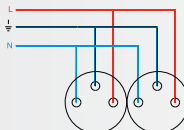
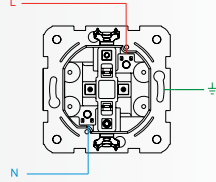
 Kanal Seçme Anahtarı	Teknik Özellikler <ul style="list-style-type: none">• 5 kanal seçme özelliği.• 100V ve 8 Ω sistemler için kullanıma uygun.• Vidalı tip bağlantılı.	Devre Şeması	Bağlantı Şeması 
 Priz	Teknik Özellikler <ul style="list-style-type: none">• 16 A, 250 V~• İki kutuplu.• Vidalı veya vidasız (çabuk bağlantılı) montaj seçeneği.	Devre Şeması 	Bağlantı Şeması 
 Çocuk Korumalı Priz	Teknik Özellikler <ul style="list-style-type: none">• 16 A, 250 V~• İki kutuplu.• Vidalı veya vidasız (çabuk bağlantılı) montaj seçeneği.	Devre Şeması 	Bağlantı Şeması 
 Topraklı Priz	Teknik Özellikler <ul style="list-style-type: none">• 16 A, 250 V~• İki kutuplu ve topraklama kontaklı.• Vidalı veya vidasız (çabuk bağlantılı) montaj seçeneği.	Devre Şeması 	Bağlantı Şeması 
 Çocuk Korumalı Topraklı Priz	Teknik Özellikler <ul style="list-style-type: none">• 16 A, 250 V~• İki kutuplu ve topraklama kontaklı.• Vidalı veya vidasız (çabuk bağlantılı) montaj seçeneği.	Devre Şeması 	Bağlantı Şeması 
 Çocuk Korumalı UPS Topraklı Priz	Teknik Özellikler <ul style="list-style-type: none">• 16 A, 250 V~• İki kutuplu ve kontak çubuğu biçimli topraklama kontaklı.• Vidalı veya vidasız (çabuk bağlantılı) montaj seçeneği.	Devre Şeması 	Bağlantı Şeması 

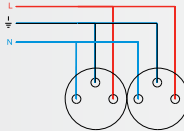
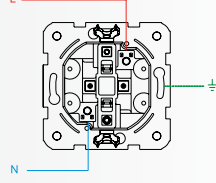
<p> Kapaklı Topraklı Priz</p>	<p>Teknik Özellikler</p> <ul style="list-style-type: none"> • 16 A, 250 V~ • İki kutuplu ve topraklama kontaklı. • Vidalı veya vidasız (çabuk bağlantılı) montaj seçeneği. 	<p>Devre Şeması</p> 	<p>Bağlantı Şeması</p> 
<p> İkili Priz</p>	<p>Teknik Özellikler</p> <ul style="list-style-type: none"> • 16 A, 250 V ~ • İki kutuplu. • Vidalı bağlantı. 	<p>Devre Şeması</p> 	<p>Bağlantı Şeması</p> 
<p> İkili Topraklı Priz</p>	<p>Teknik Özellikler</p> <ul style="list-style-type: none"> • Fitreli ve EMC uyumlu. • Sigortalı 2.5A (değiştirilebilir). 	<p>Devre Şeması</p> 	<p>Bağlantı Şeması</p> 
<p> Çocuk Korumalı İkili UPS Topraklı Priz</p>	<p>Teknik Özellikler</p> <ul style="list-style-type: none"> • 16 A, 250 V~ • İki kutuplu ve kontak çubuğu biçimli topraklama kontaklı. • Vidalı bağlantı. 	<p>Devre Şeması</p> 	<p>Bağlantı Şeması</p> 
<p> Çocuk Korumalı İkili Topraklı Priz</p>	<p>Teknik Özellikler</p> <ul style="list-style-type: none"> • 16 A, 250 V~ • İki kutuplu ve kontak çubuğu biçimli topraklama kontaklı. • Vidalı bağlantı. 	<p>Devre Şeması</p> 	<p>Bağlantı Şeması</p> 



TV Prizi

Teknik Özellikler

- Ekranlıdır. Havadan yayılan radyo sinyallerinden etkilenmez.
- Vidalı bağlantılıdır.
- **Geçişli TV Prizi**
UHF/VHF bantlarından merkeze anten sistemiyle alınan yayının prizden prize geçiş yaparak veya çok katlı binalarda kattan kata geçirilerek birden fazla TV alıcısına dağıtıldığı durumlarda kullanılır.
- **Sonlu TV Prizi**
İnternet, kablolu TV veya merkezi uydu gibi yayınların dağıtımı için kullanılan yıldız dağıtım sisteminde kullanılır. Ayrıca ortak anten sistemlerinin sonunda da kullanılabilir.
- **Dirençsiz TV Prizi**
Bağımsız internet, kablolu TV veya uydu yayını sistemlerinde ve bağımsız antenli alıcılarda kullanılır.
- Amplifikatörden sonra takılacak olan priz, 20 dB, 18 dB, 12 dB, ve 8 dB'lik geçişli, sonlu ve dirençsiz prizler arasında 60-85 dBuV arasındaki TV sinyalinin seviyesine uygun olarak seçilmelidir.

Devre Şeması

Bağlantı Şeması

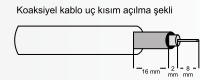
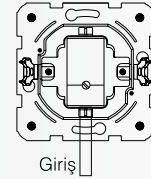
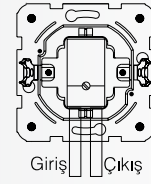

TV - Radyo Prizi

Teknik Özellikler

- Ekranlıdır. Havadan yayılan radyo sinyallerinden etkilenmez.
- Çabuk bağlantı (vidasız) klemenslidir.
- İnternet, interaktif uygulamalar, kablolu TV ve UHF / VHF bantlarından yayın alımında kullanılır.
- Amplifikatörden sonra takılacak olan priz, 20 dB, 15 dB, 12 dB, 10 dB ve 7 dB'lik ve sonlu prizler arasında 60-85 dBuV arasındaki TV sinyalinin seviyesine uygun olarak seçilmelidir.

Devre Şeması

Bağlantı Şeması

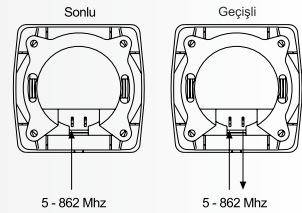

TV - SAT Prizi

Teknik Özellikler

- Ekranlıdır. Havadan yayılan radyo sinyallerinden etkilenmez.
- Çabuk bağlantı (vidasız) klemenslidir.
- İnternet, interaktif uygulamalar, kablolu TV ve UHF / VHF bantlarından yayın alımında kullanılır.
- Amplifikatörden sonra takılacak olan priz, 11 dB, 8 dB'lik geçişli ve sonlu prizler arasında 60-85 dBuV arasındaki TV sinyalinin seviyesine uygun olarak seçilmelidir.

Devre Şeması

Bağlantı Şeması

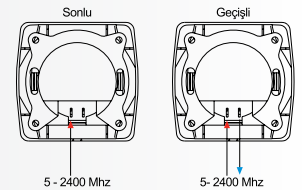

TV - Radyo - SAT Prizi









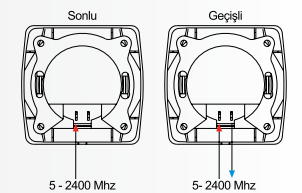

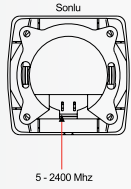
Teknik Özellikler

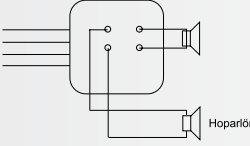
İnternet, interaktif uygulamalar, kablolu TV ve UHF / VHF bantları ile uydudan yayın alımında kullanılır.

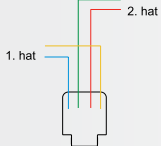
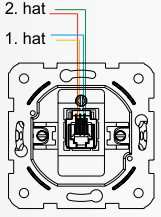
Devre Şeması

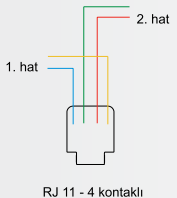
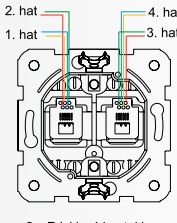
Bağlantı Şeması

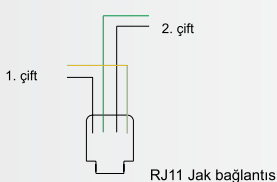
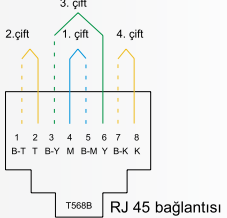

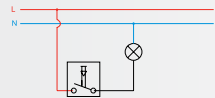
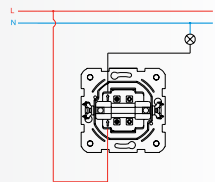
<p> TV - Radyo - SAT - Sat Prizi</p>	<p>Teknik Özellikler</p> <ul style="list-style-type: none"> • Ekranlıdır. Havadan yayılan radyo sinyallerinden etkilenmez. • Vidalı bağlantı klemenslidir. • İnternet, interaktif uygulamalar, kablolu TV ve UHF / VHF bantlarından yayın alımında kullanılır. 	<p>Devre Şeması</p>	<p>Bağlantı Şeması</p> 
<p> Müzik Yayın (Hoparlör) Prizi</p>	<p>Teknik Özellikler</p> <ul style="list-style-type: none"> • Müzik yayın kaynağından gelen yayının hoparlöre çıkışı için kullanılır. • 4Ω 5W uygulamalar için. • Vidalı bağlantılı klemenslidir. 	<p>Devre Şeması</p> 	<p>Bağlantı Şeması</p>
<p> Nümeris Telefon Prizi</p>	<p>Teknik Özellikler</p> <ul style="list-style-type: none"> • RJ11 4 kontaklıdır. • 2 telefon hattı bağlanabilir. Yeşil ve kırmızı teller 1. hat, sarı ve siyah teller de 2. hat içindir. 	<p>Devre Şeması</p> 	<p>Bağlantı Şeması</p> 
<p> İkili Nümeris Telefon Prizi</p>	<p>Teknik Özellikler</p> <ul style="list-style-type: none"> • RJ11 4 kontaklıdır. • Her bir konnektör için 2 telefon hattı bağlanabilir. Yeşil ve kırmızı teller 1. hat, sarı ve siyah teller de 2. hat içindir. 	<p>Devre Şeması</p>  <p>RJ11 - 4 kontaklı</p>	<p>Bağlantı Şeması</p>  <p>2 x RJ11 - 4 kontaklı</p>
<p> Data - Nümeris Telefon Prizi</p>	<p>Teknik Özellikler</p> <ul style="list-style-type: none"> • Nümeris jacki RJ11 4 kontak. • Data Jacki EIA/TIA 568 standartlarına uygundur; RJ45 • EIA/TIA 568 A ve B standartlarını destekler. • Pinler hem 568 A hem de 568 B'ye göre işaretlenmiştir. 	<p>Devre Şeması</p>  <p>RJ11 Jak bağlantısı</p>	<p>Bağlantı Şeması</p>  <p>T568B RJ45 bağlantısı</p>
<p> İpli Acil Uyarı Butonu</p>	<p>Teknik Özellikler</p> <ul style="list-style-type: none"> • Bir uyarı sistemini aktif hale geçirmek için kullanılır. • 10 A, 250 V~ • Bir kutuplu, bir yönlü. • Ani basmalı tip. • Vidalı veya vidasız (çabuk bağlantılı) montaj seçeneği. 	<p>Devre Şeması</p> 	<p>Bağlantı Şeması</p> 



Tekli Data Prizi

Teknik Özellikler

- EIA/TIA 568 standartlarına uygundur; RJ45
- EIA/TIA 568 A ve B standartlarını destekler.
- Pinler hem 568 A hem de 568 B'ye göre işaretlenmiştir.

Devre Şeması

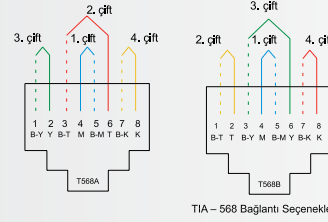

Bağlantı Şeması



İkili Data Prizi

Teknik Özellikler

- EIA/TIA 568 standartlarına uygundur; RJ45
- EIA/TIA 568 A ve B standartlarını destekler.
- Pinler hem 568 A hem de 568 B'ye göre işaretlenmiştir.

Devre Şeması

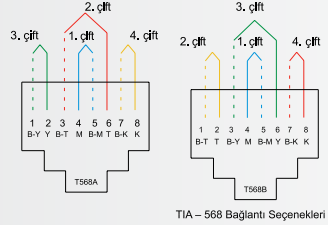

Bağlantı Şeması



Standart Energy Saver

Teknik Özellikler

- Başta otel odaları olmak üzere genel kullanımlı binalarda ciddi boyutlara varan enerji kaybını önlemek ve emniyeti sağlamak için kullanılır.
- Energy Saver Anahtarlığı duvar ünitesindeki yuvasına takılınca sisteme enerji verir. Kartı duvardaki yuvasından çıkartınca 15-20 sn. sonra sistemin enerjisi kesilir.
- Minibar gibi devamlı enerjili olan cihazlar sistemin dışında bırakılır.
- Sistemin by-pass özelliği vardır. (Energy Saver arızalandığında elektrik enerjisini kesmez.)
- Pano ünitesi çalışma gerilimi 175-250V'tur.
- Duvar ünitesi 12/24V gerilim vardır (220 V uygulayınız).
- Sigorta çıkışına takılan röle ünitesinde 3 x 10A röle vardır. Toplam 30A değerindedir.

Devre Şeması

Bağlantı Şeması

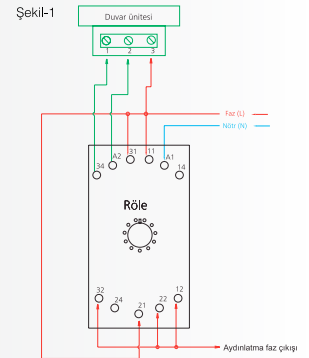

İnce Kartlı Energy Saver

Teknik Özellikler

- Başta otel odaları olmak üzere genel kullanımlı binalarda ciddi boyutlara varan enerji kaybını önlemek ve emniyeti sağlamak için kullanılır.
- Energy Saver, kartı duvar ünitesindeki yuvasına takılınca sisteme enerji verir. Kartı duvardaki yuvasından çıkartınca 15-20 sn. sonra sistemin enerjisi kesilir.
- Minibar gibi devamlı enerjili olan cihazlar sistemin dışında bırakılır.
- Sistemin by-pass özelliği vardır. (Energy Saver arızalandığında elektrik enerjisini kesmez.)
- Pano ünitesi çalışma gerilimi 175-250V'tur.
- Duvar ünitesi 12/24V gerilim vardır (220 V uygulayınız).
- Sigorta çıkışına takılan röle ünitesinde iki adet 15A röle vardır. Biri aydınlatmayı, diğeri klimayı besler. İstendiğinde röle ünitesine üçüncü röle eklenebilir.
- Manyetik kapı kontağı ile kapı veya pencere açıldığında klima enerjisinin kesilmesi sağlanır.

Devre Şeması

Bağlantı Şeması

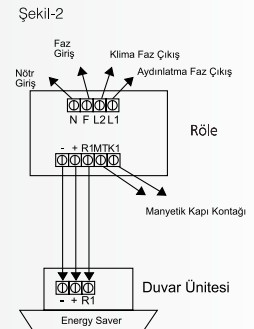

Sürdürülebilir ve aydınlık gelecek için **yeni nesil teknolojiler.**



VİKO olarak, sürdürülebilir gelişimin, topluma yapılan katkıyla ve doğal kaynakların bilinçli kullanılmasıyla mümkün olabileceğine inanıyoruz. Mevcut enerjilerin ve doğal kaynakların daha verimli kullanımı için gerekli önlemleri alıyoruz. Ürünlerimizde, tasarım aşamasında, üretimde ve kullanımda, çevreye olumsuz olabilecek etkileri en aza indirecek malzeme ve teknolojileri tercih ediyoruz. Görüyoruz, gelecek daha yeşil ve daha aydınlık.



DOĞANIN
güzelliğine
'dokun'
muyoruz

www.viko.com.tr





VİKO Elektrik ve Elektronik Endüstrisi San. ve Tic. A.Ş.
Abdurrahmangazi Mah. Ebubekir Cad. No: 44
34887 Sancaktepe / İstanbul
Tel: 0216 564 55 55 pbx Faks: 0216 564 55 44
Web: www.viko.com.tr E-mail: viko@viko.com.tr